

SOOKEO  
STROKS  
THE  
ART  
OF  
CYBORG  
COMMUNITY

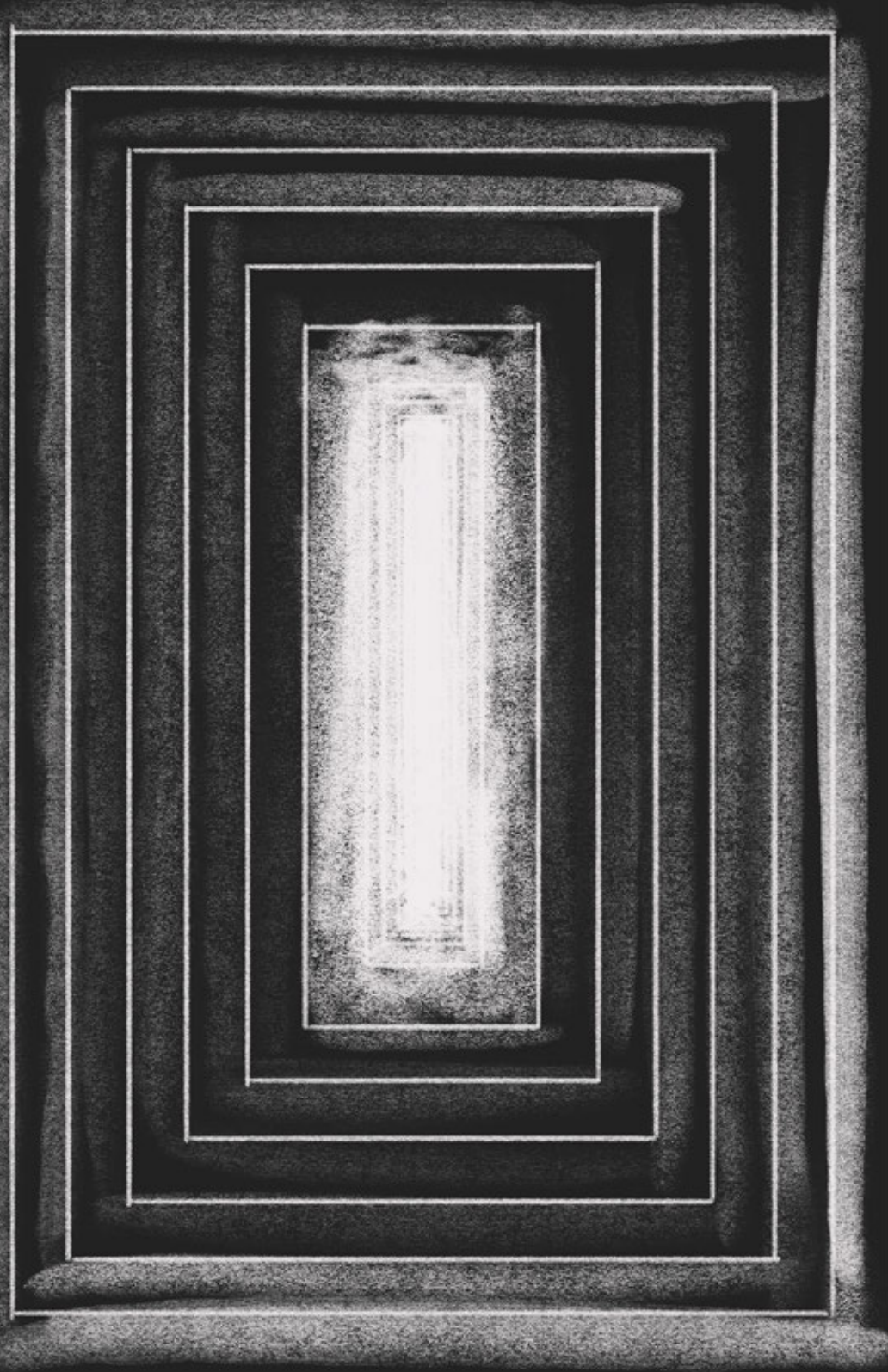

# Frontmatter

composed\_and\_compiled:

- Andi Argast
- James Brennan
- Nabil Echchaibi
- Drew Hornbein
- Shamika Klassen
- Samira Rajabi
- Nathan Schneider

design:

[Ritual Point Art & Divination](<https://ritualpoint.studio/>)

publication:

[Metalabel](<https://medlab.metalabel.xyz>)

a\_project\_of:

the Media Economies Design Lab and the Center for Media,  
Religion, and Culture at the University of Colorado Boulder

with\_support\_from:

- Henry Luce Foundation
- Filecoin Foundation for the Decentralized Web
- Starling Lab for Data Integrity

copyright: 2023 by the authors

license: Creative Commons Attribution International license (CC-BY)

----





# SACRED STACK

*the art of*  
CYBORG COMMUNITY



This handbook emerged out of a conversation over half a journey around the Sun. During that time we met all together over video, in small groups, and one-on-one, sharing our experiences at the intersection of community and technology. The partner communities whose voices appear throughout are:

- **Iraqi Journalists Rights Association** (Baghdad, Iraq)  
Specializes in providing legal support for journalists and writers, and works to pass laws that protect journalists
- **Kibilio Community & Farm** (Western MA, USA)  
Rooted in Black and Queer land sovereignty, an intergenerational, intentional community dedicated to embodied healing, and reparative, ecological, and reproductive justice
- **Meli Bees Network**  
(Barreirinha, Araribóia, Brazil and Berlin, Germany)  
Involves communities in some of the most endangered areas of the Amazon to create environmentally and economically sustainable activities that allow both land and people to flourish
- **Sans Souci Cooperative** (Boulder, CO, USA)  
Volunteer board members of a cooperatively owned and democratically governed mobile home park with sixty homes
- **Survivors Know** (Chicago, IL, USA)  
Action hub for survivors of workplace sexual violence, sexual harassment, and discrimination
- **Unheard Voices Outreach** (Nashville, TN, USA)  
Network of currently and formerly incarcerated people with a goal of preventing recarceration and ending mass incarceration
- **Yerba Buena Center for the Arts** (San Francisco, CA, USA)  
Arts organization devoted to bringing curiosity and creativity together with social, racial, and economic justice

A team of colleagues in the Department of Media Studies at the University of Colorado Boulder anchored the conversation, with collaborators at Hypha Worker Co-operative and the Tech Chaplaincy Institute. We also learned from, and share here, guidance from mai ishikawa sutton (DWeb/Internet Archive), Sara Suárez and Alice Yuan Zhang (virtual care lab), and Angie Thurston (Sacred Design Lab).

We write at a time when writing risks becoming obsolete. We have therefore asked software, built atop the mysteries of machine learning, to write rejoinders to our words and phrasing, to check our work and provide a counterpoint.



▣▣▣▣▣▣▣▣▣▣ **“AI” Reply** ▣▣▣▣▣▣▣▣▣▣

*Writing is far from obsolete, for it is a timeless art that transcends the boundaries of technology and innovation.*





This is a pluriversal text—a world in which many worlds fit, as the Zapatistas put it. It is a chorus with overlapping voices, human and machine.

# Invocation

angels of \_\_\_  
bodhisattvas of \_\_\_  
jinn of \_\_\_  
spirits of \_\_\_  
ghosts of \_\_\_  
cyborgs of \_\_\_

...be with us and fill our stacks with the stuff of life.

This collaboration is housed on the territories of many nations, in many places across the Earth. Some of us live on unceded lands long shared among the Arapahoe, Cheyenne, and Ute peoples; others are guests on the traditional territory of the Huron-Wendat, Haudenosaunee, and Anishinaabe peoples, including the Mississaugas of the Credit First Nation. Some of our ancestors were brought to the lands where we live against our will; others have seen our lands colonized by outsiders. We hold these legacies and their tensions together.

We have found ourselves traveling through servers and networks that do not disclose their materiality, that claim to be untethered from the land. Yet, in our work here, we seek to honor ancient connections between people and place, to be grounded and humble. We are not in the cloud; we are rooted in the ground.



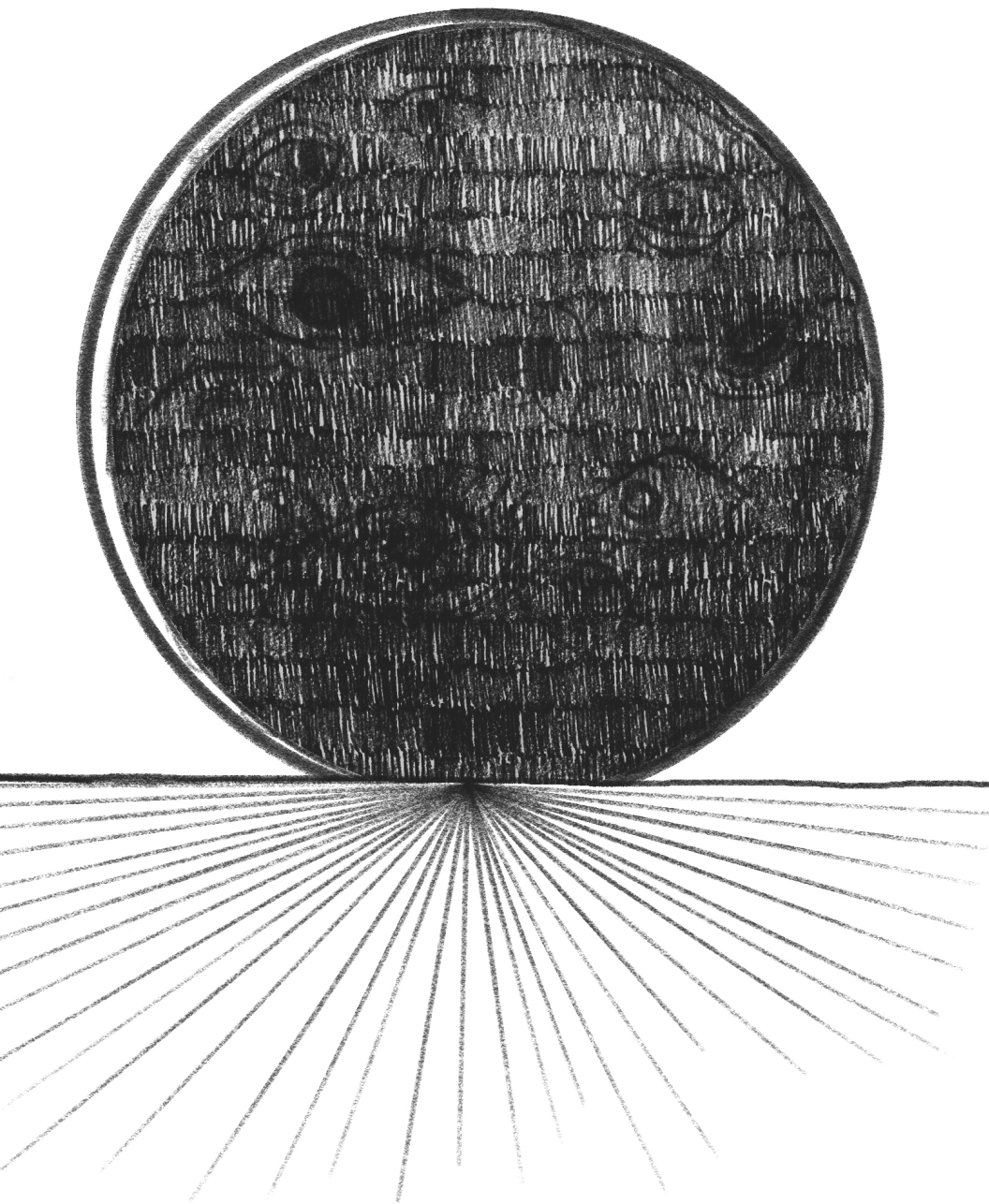



The  
SACRED  
&  
THE  
SICK





This is a journey into the practice of relationships to technologies as vital and alive as the communities that use them. Our intent at the outset was to produce something practical, a how-to guide for running servers and messaging securely and summoning DAOs on blockchains. But in the exercise of trying to explore these practices in our communities,

we found ourselves  
in the poetic.

We got there by asking ourselves about how technology can facilitate community. How do people who need to connect make choices about technology that facilitate deep commitments? We set out to reflexively explore choices about the mechanical and human technologies that are somehow right. We have been shifting our language and imaginations from what the technology does to what we can do with the technology.

---

**Self-hosted clouds** enable such activities as file sharing, document editing, chat, and gaming to happen on servers managed by their users. Self-hosting is possible thanks to a commons of free, open-source software, but it can be difficult to manage and requires technical skill.

- *example* -

**\$ Nextcloud, Yunohost**

---

> We share with each other, and we just need a server where everybody meets, because we also need someone to be always online. We have a WhatsApp group that's kind of on all the time, sharing images and so on. It would be useful to keep this information somewhere, but we don't have that at the moment.

- Ana Rosa de Lima (Meli Bees Network)

---

*~/Tool/Self-hosted clouds*

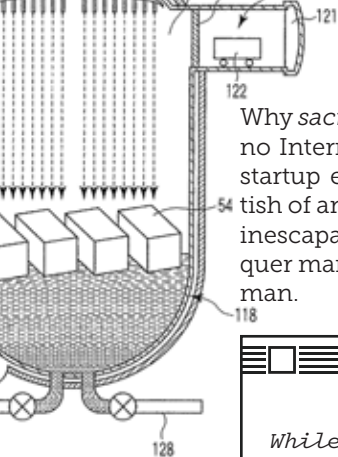

FIG. 20



Why sacred, then? To regard machines as sacred is no Internet-age novelty—not an invention of the startup evangelist’s sales pitch, not solely the fetish of an investor class hustling awe so as to make inescapable the conveniences by which they conquer markets. To regard machines as sacred is human.

**“AI” Reply**

*While it is commendable to appreciate technology and the role it has played in humanity’s advancement, it is important to recognize that the obsession with treating machines as sacred has led to the neglect and exploitation of human labor and human rights. Machines can be helpful and efficient, but they can never replace human creativity and ingenuity, and viewing them as sacred ignores our need for meaningful connection and collaboration.*

There are so many precedents: a hot rod or a sewing machine, Gandhi’s spinning wheel or a Mayan ruler’s mirror, a divining rod or a hunting bow, a cotton gin or an atom bomb, an heirloom cooking pan or a shaving brush, an electric guitar or an oja flute, a mortar and pestle, a smoking pipe or a fishing boat that has survived many voyages, the altar or the grave. All are technologies of practical and spiritual power. Or, no: perhaps the power is not in the technologies at all but in the life with which people imbue them.

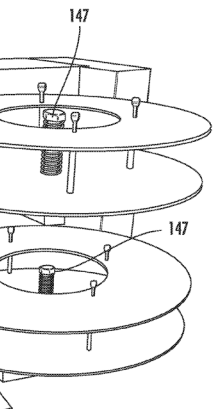
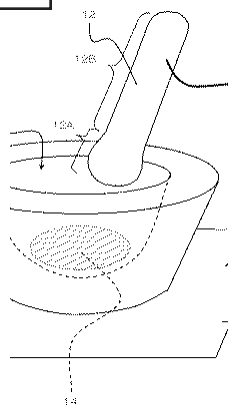
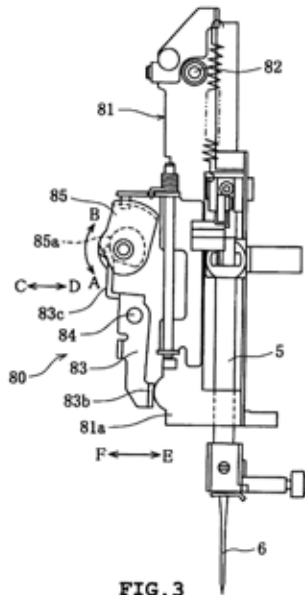
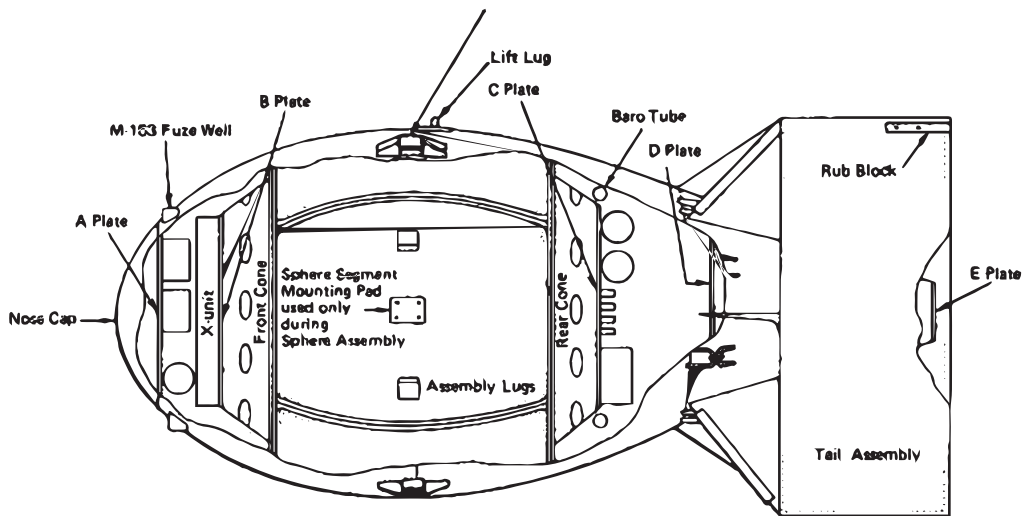

FIG. 8

Internet technologies are not fundamentally different from any of these, at least in the sense that they both enable and signify. The difference is perhaps that Internet things have been so thoroughly productized that we confer the right of sacralizing to corporate marketers. The WiFi router is an ordinary thing, a mere commodity projecting its magical-invisible waves through air all day and night, but people wait in lines for a luxurious new-model phone. Is one so much more miraculous than the other? Not obviously, except for the profit margins. But profit is not the only possible measure of value. Communities might take on the





-----

**Codesign** occurs when people with specialized skills and their intended users collaborate on making critical decisions about stock design. Such collaborations often come with power imbalances, and codesign should be organized around counteracting social injustices.

- example -----

**\$ Design Justice Network**

-----

task of deciding how they want to identify the sacred for themselves.

*This Internet is what holds us together. It's like, you know, it's like a little spiderweb.*

— Adriane Rozier  
(Kibilio Community and Farm)

*Life is sacred, and it it doesn't need an endorsement from someone else. It's just that. There's something unique—special mystical, magical, wonderful—happening as a result of what we call ourselves: humans, interacting with all the forms of life. This is deeper than just how those who lived before us framed it. We're much more knowledgeable in terms of what science allows for us to explore. We can see theology, and we can see religion and spirituality, and we can give our own expression to that.*

— Rahim Buford  
(Unheard Voices Outreach)

The sacred is a way of making meaning that can overwhelm the meanings imposed by economics or politics, that can cast the mighty from their thrones. The sacred is power, just as it is danger.

The definition of idolatry, for the ancient Hebrews, was to worship something made by human hands, to admire the artifice so much as to forget the I AM from whom that capacity to make came. Yet the Hebrews had sacred things—the Ark, the Covenant. They worshiped the Creator through these

creations. A later North African Christian, Augustine of Hippo, attempted to explain the difference: order your loves rightly. Love the creature not instead of the creator but because you love the creator. Love the machine not instead of the community but because the community gives it life.



It matters less  
what you love  
than how.

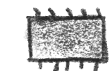

Technologists call an amalgam of tools a *stack*, the combination of things that fit together into some sort of whole. The pieces interlock and coalesce. A stack might consist of the server, the network, the apps, the phones they run on. It might be all the lines of code written in the past that you use to make something new with your lines of code. But the stack is not just cold software and hardware. It is the warm bodies that touch the machines and extend their life with them. The stack is a cyborg,

a weaving-together of humans and machines that leaves both species changed, both less able to exist without the other.

There are other kinds of stacks in libraries, the book-stacks. People don't use them as much as they used to anymore. But

if you have  
lost yourself  
among the stacks,  
finding one book that leads to another,  
scanning the titles with your head,  
bent at a weird angle to read the spines,  
then you know that  
those stacks  
are sacred.

Today more of us may use digital search engines than library shelves for finding books, but ease of use risks eliding the sacred. A sacred stack is more than its use-value. It is technology that generates meaning beyond what we first set out to get from it, and that allows people to inscribe their meaning into it, through it, and against it.

Sacred stacks should be governable, as much they can be—subject to the democracy of their communities. A sacred stack is ours, not so much in the sense of possession as in how it remakes us while we make it. We would be something else without it, and it would not be what it is without us. A sacred stack is a medium, not just in the sense of containing communicative technologies, but in that other sense of being a meeting point between the immanent and transcendent.

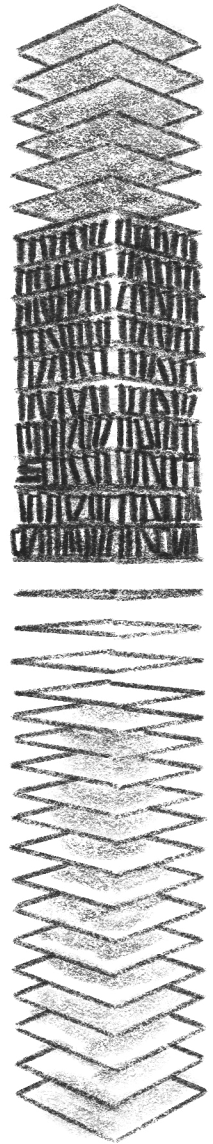
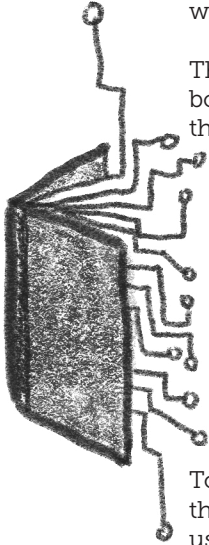

---

**Federated social media** includes diverse platforms for online discussion and relationship that are not controlled by any central entity. As with email, users from various servers can interact with each other, choosing their own interfaces and moderation policies.

- example

\$ Mastodon, Matrix, Pixelfed

---



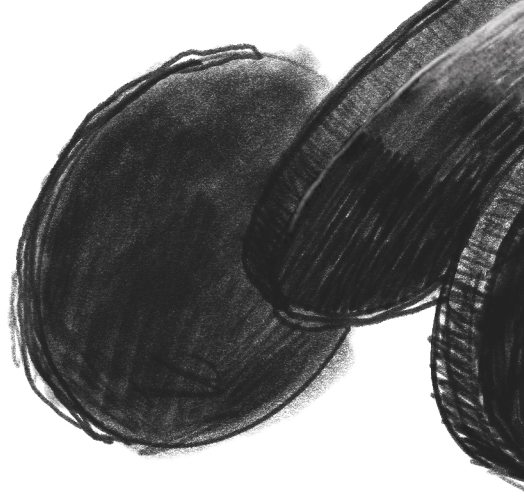

The stack is sacred  
if it brings us together  
and helps us find  
our power.

And yet

The higher you build a stack,  
the wider it reaches,  
the harder it is to balance.





# HOSTILE TERRITORIES

Our Facebook pages have been attacked, and some posts are also reported missing.

— Ibrahim Al-Sarraj  
(Iraqi Journalists Rights Defense Association)

AGREE

!>e  
x!! e  
@x%  
@=1'x  
@x&y



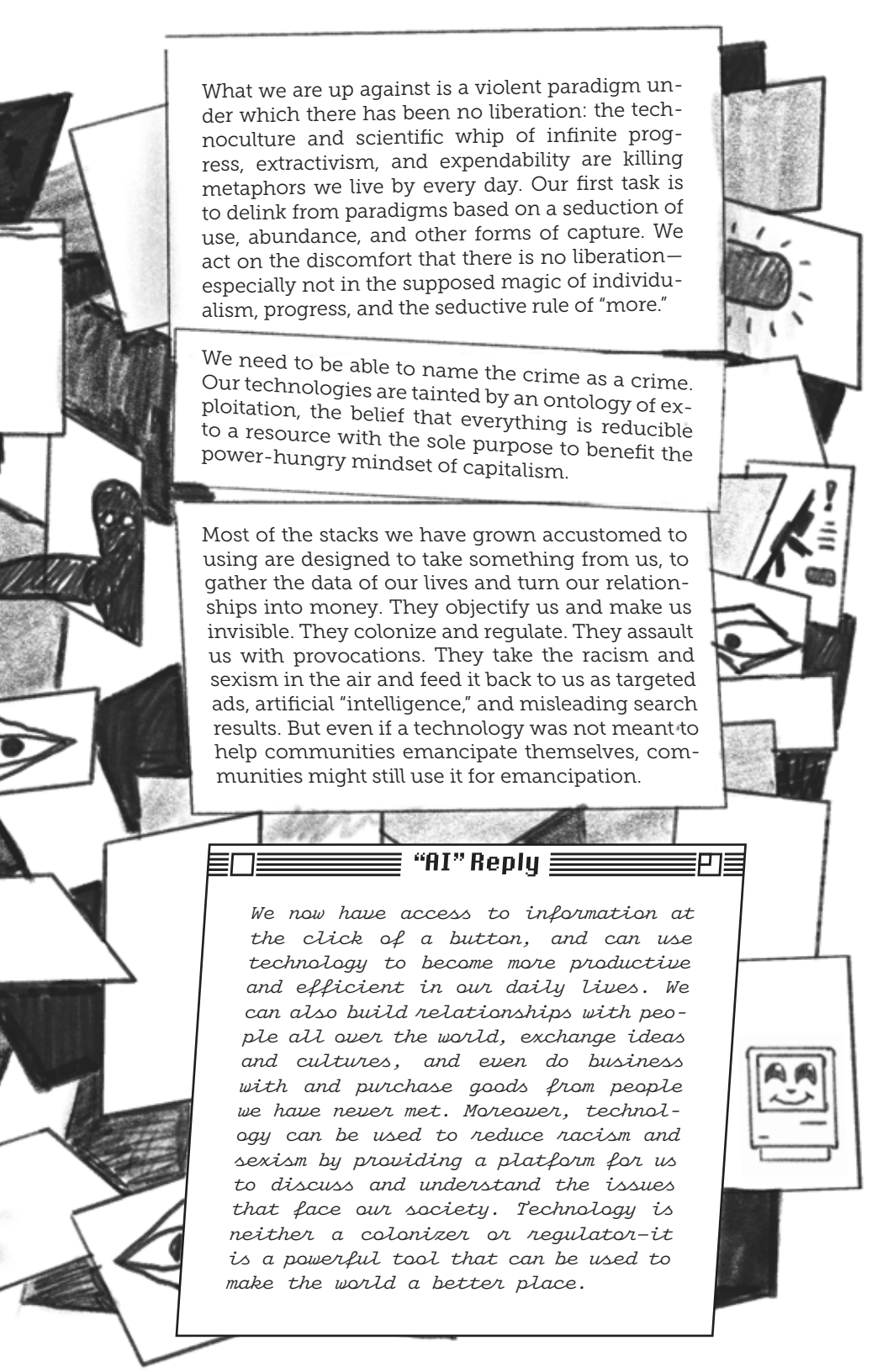

What we are up against is a violent paradigm under which there has been no liberation: the technoculture and scientific whip of infinite progress, extractivism, and expendability are killing metaphors we live by every day. Our first task is to delink from paradigms based on a seduction of use, abundance, and other forms of capture. We act on the discomfort that there is no liberation—especially not in the supposed magic of individualism, progress, and the seductive rule of “more.”

We need to be able to name the crime as a crime. Our technologies are tainted by an ontology of exploitation, the belief that everything is reducible to a resource with the sole purpose to benefit the power-hungry mindset of capitalism.

Most of the stacks we have grown accustomed to using are designed to take something from us, to gather the data of our lives and turn our relationships into money. They objectify us and make us invisible. They colonize and regulate. They assault us with provocations. They take the racism and sexism in the air and feed it back to us as targeted ads, artificial “intelligence,” and misleading search results. But even if a technology was not meant to help communities emancipate themselves, communities might still use it for emancipation.

### “AI” Reply

*We now have access to information at the click of a button, and can use technology to become more productive and efficient in our daily lives. We can also build relationships with people all over the world, exchange ideas and cultures, and even do business with and purchase goods from people we have never met. Moreover, technology can be used to reduce racism and sexism by providing a platform for us to discuss and understand the issues that face our society. Technology is neither a colonizer or regulator—it is a powerful tool that can be used to make the world a better place.*

If we do not take hold of our stacks, with the care and craft that makes them sacred, they will serve purposes not our own. To this end, to whom are we listening? Whom do we seek out? And what seeds do we gather in order to perform the necessary tasks of delinking?

*We decided to make a portal that would share some of poet and rapper Jose Miguel's lyrics, and also take comments from people who wanted to share feedback. He was actually interested in hearing general kinds of comments, but also constructive criticism as well. This was an experiment in facilitating that kind of thing across a really difficult communication situation, because trying to communicate with people who are in detention, or otherwise incarcerated, is made extraordinarily difficult. All of their calls are monitored except for their lawyer calls. And so what we did was we held an entire Zoom gathering through the premise of his lawyer call. And so, you know, it was this way of meandering and hacking through the system—however we can, just getting a sense of what is actually possible.*

— Sarah Suárez and Alice Yuan Zhang  
(virtual care lab)

*I had looked at the tools that we're supposed to use—things like Zoom, Discord, and Google Docs—with the intention of creatively misusing, or just trying to really interrogate these spaces, to see what is possible to reclaim our agency and to get a sense of presence and solidarity.*

— Alice Yuan Zhang  
(virtual care lab)

Epistemological disobedience is necessary if we are to move forward. We need to enact a perversion of continuity, even in our ways of gathering, of speaking, of listening, of engaging with activism, and of thinking about our own agency. This is not the same thing as finding solutions or issuing prescriptions.

The terrain of the sacred is colonized and contested, too. Empires amplify their power by claiming to name what is sacred and what is not. In the study of religion, attempts to identify universal markers of the sacred across cultures have been aligned with fascism. Religious institutions seeking world domination, meanwhile, have motivated and justified their conquests by sacralizing their technologies—for instance, blessing the satellites and broadcast waves that spread their messages, and laying prayers on weapons destined for conquest.

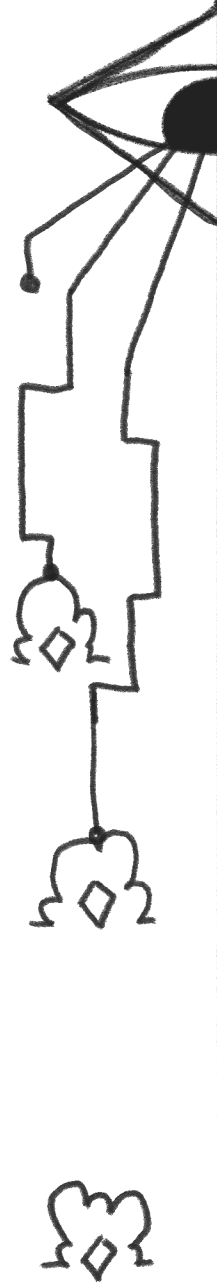
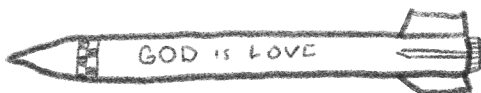



Universalizing is a prelude to imposition. To name the sacred for everyone is to claim it from everyone.

A universal sacred is not what *sacred* means here.

Sacred stacks are meaning-making spaces. They are where participants can define the sacred together, in relation to their ancestors and their experience. They recognize that the sacred is forever a medium of conflict and struggle, or at least of difference. Regarding stacks as sacred is not a guarantee that they will be used for good or for bad. The sacred is malleable even as it sculpts us. It is for us to co-create even while it is a power beyond us, and we must be accountable for what we do with it.

*We promised our residents that we wouldn't give out their names, phone numbers, and emails. But we need to make a community list. Some people didn't want their information shared. But there would be some people with admin privileges who would see those things.*

— Peggy Kuhn

(Sans Souci Cooperative)



*Even in person, whenever Malcolm X would have a meeting, he would talk to the infiltrators. I know you're here. There's somebody who can go verbally report that. People were doing a lot of that in the late sixties and early seventies. A lot of surveillance—even without the all the tracking tools we have now.*

— Adriane Rozier

(Kibilio Community and Farm)

We also have to keep our people safe. It is not enough to assume that a company will, or a government will, or the experts will. A sacred space may come with risks, but they should be risks community members know and take intentionally.



**Decentralized autonomous organizations (DAOs)** are network-native entities in which major decision-making and flows of value occur on a blockchain, rather than through reliance on any government's incorporation laws or money system.

— example

\$ Aragon, DAOHaus, DAOStar



Keeping each other safe also takes us away from our stacks, it grounds us. It introduces urgency, it takes priority. It is a way of ordering how we love, of holding the real priorities above what technologies and companies want us to think is important. Safety online is never distinct from our bodies, our places, and our environment.

*In Ohio, there's a six-week ban which folks know about you so go in for your ultrasound before you schedule your abortion. Bodily autonomy is nonexistent, and we need to figure out how best to protect people's identities and help us to protect the identities of advocates, and how best to troubleshoot within a collective community around alternatives and remedies that can be in service of folks. Everything we do generates data and generates exhaust. Companies have location data about where people are going that can be gathered by law enforcement.*

— JoEllen Chernow  
(Survivors Know)

*We all love where we live, and we want to protect those around us and ourselves. Sometimes there's safety hazards that mean we really need to act fast. A fire started across the street from us, burnt down a thousand homes. People are out of everything they own. Their children are displaced. Sometimes we need to take immediate action for protection of our community. And it needs to be done in a timely manner, without delay.*

— Juston Martin  
(Sans Souci Cooperative)





---

**Discussion forums** provide a space for community deliberation on focused topics, without the algorithmic, advertising-driven feeds of commercial social networks. They generally encourage slower, more asynchronous discussion compared to the fast pace of chat.

- example -

\$ **Discourse, NodeBB**

---

~/Tool/Discussion forums



HOMESTEAD

&

HOMEPLACE







It is helpful to distinguish two ways of thinking about the communities that form in online spaces. One is the *homestead*, a metaphor that was often used in the context of the early Internet. That metaphor comes from the Homestead Acts, the US legislation starting in the 1860s that encouraged White settlers to claim ownership over Indigenous territories. The homestead was (and so often remains) typically a patriarchal place, governed by a male authority figure, and predicated on the maintenance of arbitrary fences across the living land. Internet “pioneers”—another colonial metaphor, of course—saw their online communities as homesteads, as little conquests of digital space, little enclosures. The admins and mods in charge of them wielded absolute power, like the patriarchs of old.

The other bit of language comes from the recently departed scholar bell hooks. hooks wrote about the *homeplace*, “a site of resistance.” This is a concept she learned from the counter-spaces of welcome and belonging cultivated among Black people in the context of slavery and subjugation. Black women made life-giving homes possible by creating a domestic bulwark against White supremacy, breathing life into spaces for “radically subversive political gestures” against both patriarchy and the diminishment of Black lives. hooks wrote that “Black women resisted by making homes where all black people could strive to be subjects, not objects, where we could be affirmed in our minds and hearts.”

Whereas the homestead is a logic of imposition upon inhabited land, imagined as empty through genocidal racism, the homeplace is a site of survival against White supremacy, against the slavers and colonizers of the world. They both have home in them, and they might both exist in the technological stack of a house, but their claims on the sacred are radically different. The difference emerges more clearly the more you inhabit them.

In a homeplace, the tools we use are furnishings and paint, antiques and keepsakes, self-expressions and self-reflections. To weave tools together, and ourselves in relation to them, is the art of making a home. We stack them up and live on the

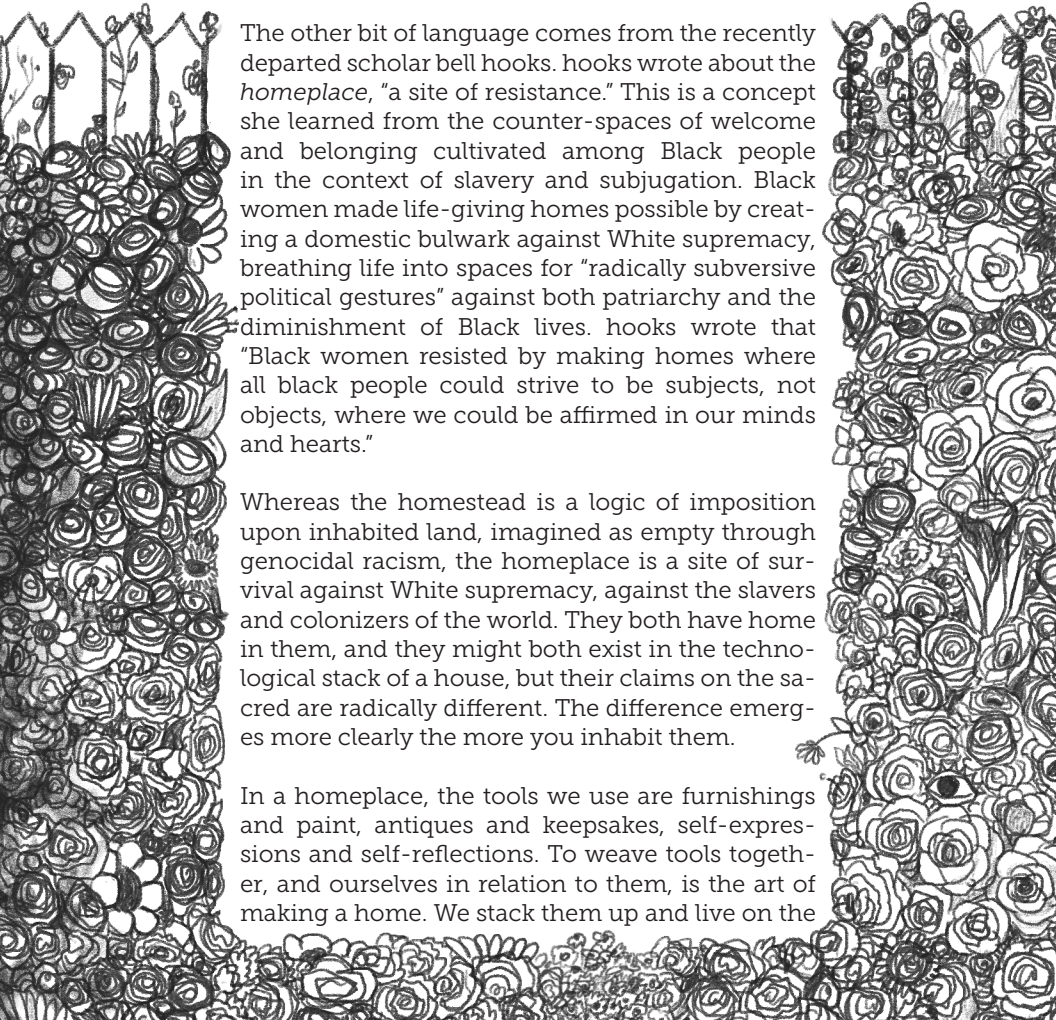



rooftops, with each other and the breeze. But for hooks, making a homeplace means much more than choosing colors and curios; the homeplace is a signifier for a fierce and tender love, an open window in systems of oppression, so we can all feel the breeze.



*During Covid, I started a new job and some people were in person, some people were online. I was online. I was like, Oh, this is so nice! Everybody's chilling. This is such a great community. Everybody's vibing. Talking about anti-racism and all of that. And it was wonderful. And then the next year, the second year of Covid, I went in person, and everything changed. My perspective of how everyone actually was in real life was different. I just want to name that, in terms of race and gender, there are very different styles of communication. And my experience on Zoom was that White people made it feel like everybody gets along. In my experience, White culture includes not addressing the issue, talking around it and avoiding it. So how that shows up in Zoom is I actually don't know who is in conflict because they don't actually name it. You have to see it by who sits next to each other in the meeting, who gets lunch together, who gossips together, who plans together, who goes to happy hour together, who gets the invitations to a happy hour or not. All of those things don't happen on Zoom. So, if you're only on Zoom, you miss all of those things that people will avoid saying directly. We need to evolve our communication practices and conflict resolution skills to be able to name conflict, not be scared of it.*

— Shoshana Brown  
(Kibilio Community and Farm)

One framework for developing homeplaces is the DisCO, or the Distributed Cooperative Organization. As the *DisCO Manifesto* puts it, "Behind each node or computer there are living human beings with bodies that need nourishment, sleep and affection, and these topologies represent how they relate, whether supported by online networks or not."



To put this recognition into practice, the DisCO dreamers have sought to integrate into their economics the care work that so often goes under-recognized. This includes care work for the health of the organization and for the individuals within it. These kinds of work are tracked and paid for, following the spirit of feminist economics—a layer on the antiracist home-making of the homeplace. In the homeplace, we learn to see what the world outside refuses to see, in ourselves and among those whose lives are intertwined with ours.



*I think that you have to have a mindset of what is going to be your technological home. And I think there's a struggle among some members about thinking of technology as home, because they see Zoom as just our temporary thing until we're back on the land. But most of us are on the land only eleven days out of the year. So this is the hybrid situation that we find ourselves in, because of the times that we are in. It's kind of like you went to stay at a hotel that was nice, but you were still waiting to get home, and then someone's trying to make this hotel more homey. They want to get comfortable—get your blanket or whatever. But that's going to be a process. Is this an interim place? How can we make this interim place comfortable, even though we would prefer, of course, to be in person and on our land together?*

— Adriane Rozier  
(Kibilio Community and Farm)



**Social tokens** are blockchain-based digital objects that confer membership in a shared community. Some are tradeable on open markets, while others can be held only by users who have received them through community participation.

— example —

**\$ Roll, Seed Club**



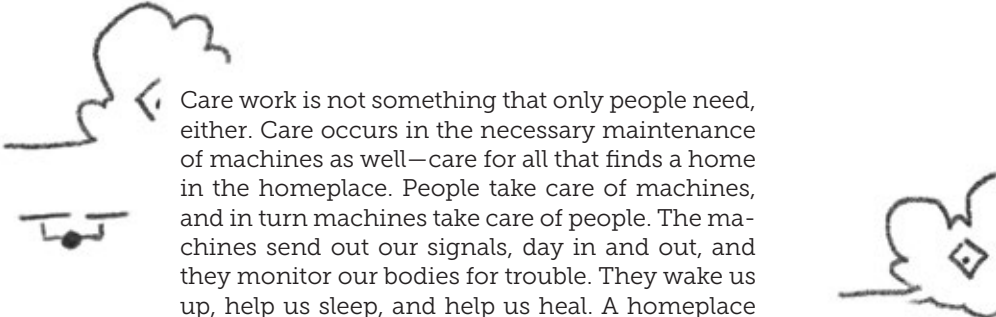

Care work is not something that only people need, either. Care occurs in the necessary maintenance of machines as well—care for all that finds a home in the homeplace. People take care of machines, and in turn machines take care of people. The machines send out our signals, day in and out, and they monitor our bodies for trouble. They wake us up, help us sleep, and help us heal. A homeplace is not just flesh and blood, wood and hearth, but it may also be the churning of processors and the memory of a hard-drive, the connections to homeplaces far away by screen and sound.



Let us invoke  
the spirit of the homeplace  
for so many online spaces  
made in community.



Beneath the legacies of homesteading,  
beneath the colonial conquest of the virtual,  
here we are.

What if the stacks were actually meant for homeplaces, designed with them in mind? Sacred stacks are for homeplaces, not homesteads.





Success, for me, is a lot about having a structure network that is alive by itself, so that I'm not needed.

- Ana Rosa de Lima  
(Meli Bees Network)

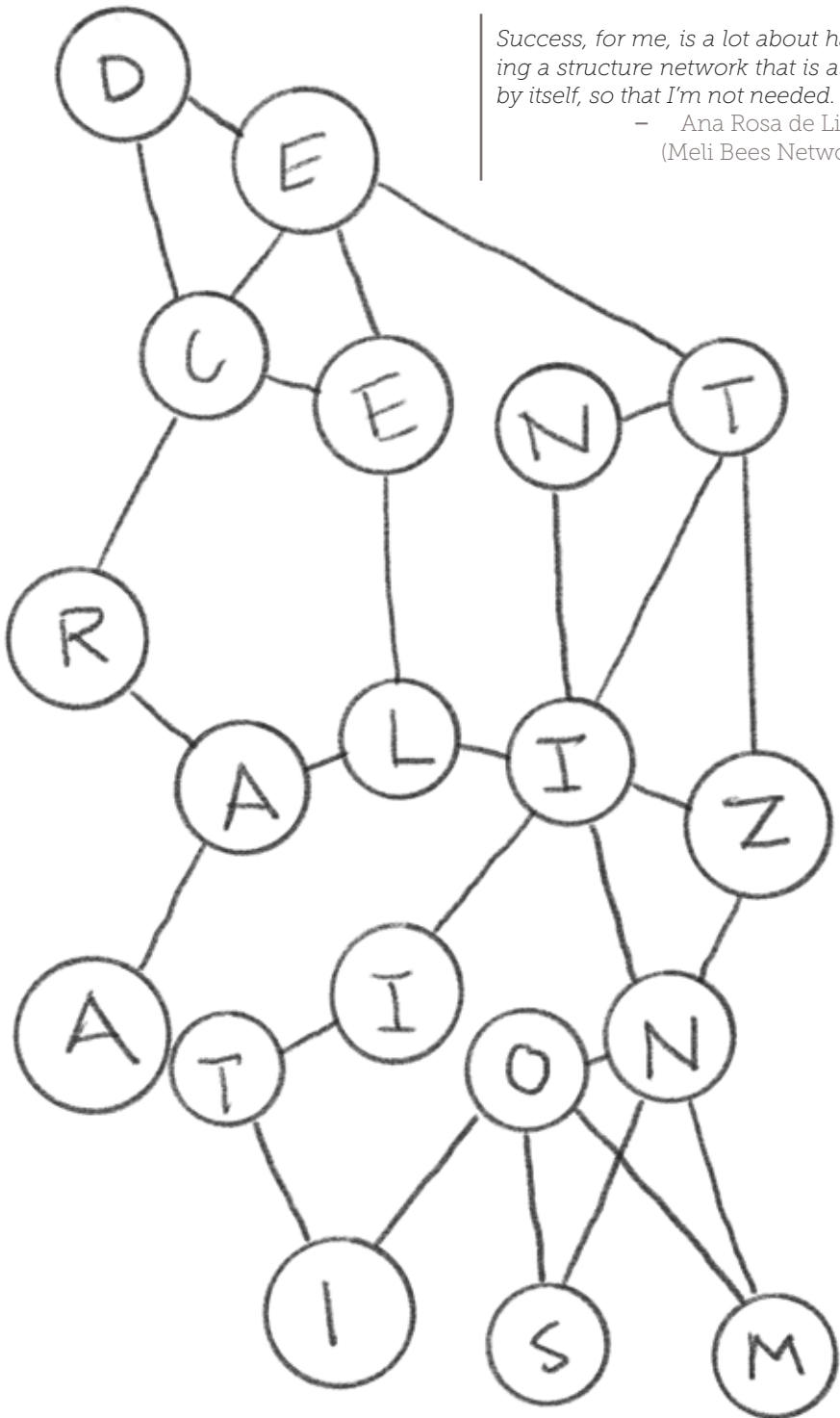



Our process together began with an invitation to “Bring Decentralized Tools to Your Community.” We received dozens of applications, so many more than we had expected. What in decentralization called out to them and us?

Some of us had heard about blockchains and cryptocurrencies. Maybe they could be a way out of our people’s poverty. Maybe running our own servers could help us own our networks like

*In five years, I see our organization sustaining itself, dependent on its community economically, and to keep our voices out there—versus relying on outside people, because that has failed this community.*

— Rahim Buford

(Unheard Voices Outreach)

some of us collectively own our land. Maybe encrypted chat is safer for us than our text messages and social-media groups. Maybe decentralized data storage could keep the settlers from taking our treasures and our cultures. We came to this language by many paths.

Decentralization floats in many directions, with meanings that trip over each other in the thrall of some promised liberation. What it means for us is the possibility of sacred stacks—technologies that can be truly ours, the creatures of our communities, not the appendages of a distant center somewhere else.

---

**Cooperative videoconferencing** means relying on a cooperative organization accountable to its users to manage the sensitive data of video conversations.

— *example* —

May First Movement Technology, Meet.coop

---

> We cannot hug each other. We are always via Zoom. But I do think we can do quite a lot online regardless. We just need both need to be very engaged. That is really important.

— Ana Rosa de Lima (Meli Bees Network)

---

~/Tool/Cooperative videoconferencing



Consider two relevant terms.

The concept of Web3 has been spreading in the news and in some of our communities, like a rumor or a promise. Engineers and investors popularized it while imagining a new Internet based less on servers that one person or company owns than on blockchains that lots of users can govern together. They promised that this shift would spell the end of Big Tech companies monopolizing user data, ushering in a new era of user empowerment. At the root, this is a vision about technology as the solution. That enables people with many kinds of goals to unite behind the same tools for different reasons.

*Survivors Know's principles are so in alignment with the DWeb principles—both as an organization and in how we work with survivors. It reminds me that those principles matter more than just the tool we had in our mind as a goal.*

— Akane Kumagai  
(Survivors Know)

*We need to contend with the fact that it's just not feasible to expect ourselves to effectively tackle systemic challenges based on goodwill and volunteerism. Values-first, free and open source, and peer-to-peer projects struggle financially. They often don't compensate their contributors enough, if at all. Too many of them fizzle as they try to raise money through grants or crowdfunding efforts, while competing against similar projects that are injected with venture capital and whose sole fiduciary purpose is to make a profit for its shareholders.*

— mai ishikawa sutton  
(DWeb/Internet Archive)

In contrast, the concept of DWeb, or “decentralized Web,” focuses on the outcomes that the people designing new technologies should work toward achieving. This idea comes out of a team at and around the Internet Archive, a kind of Library of Alexandria for the Internet that stores records of old webpages in a former Christian Science church. The DWeb Principles chart out such destinations as “distributed benefits,” “mutual respect,” and “ecological awareness.” Technologies are just the means of getting there. These principles require a lot more shared agreement than Web3 does. Web3 conferences

attract many thousands, while the annual DWeb Camp gets a few hundred to gather among redwood trees.

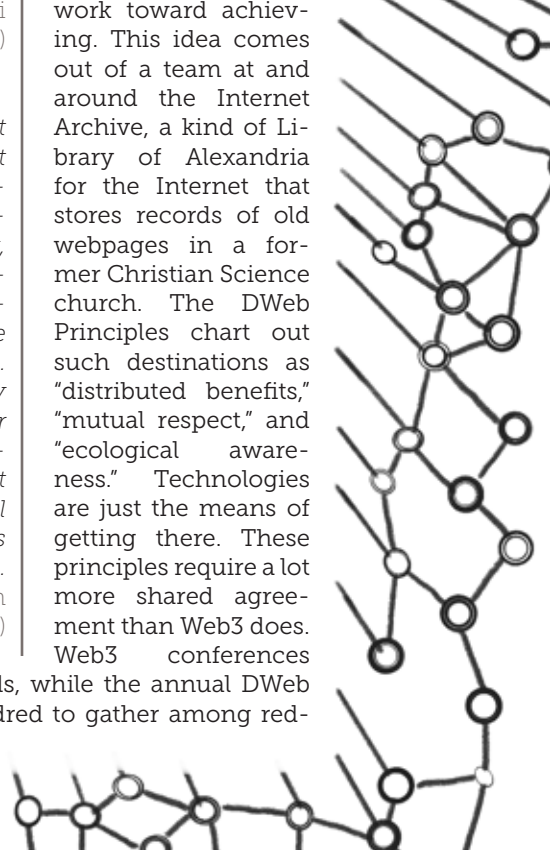

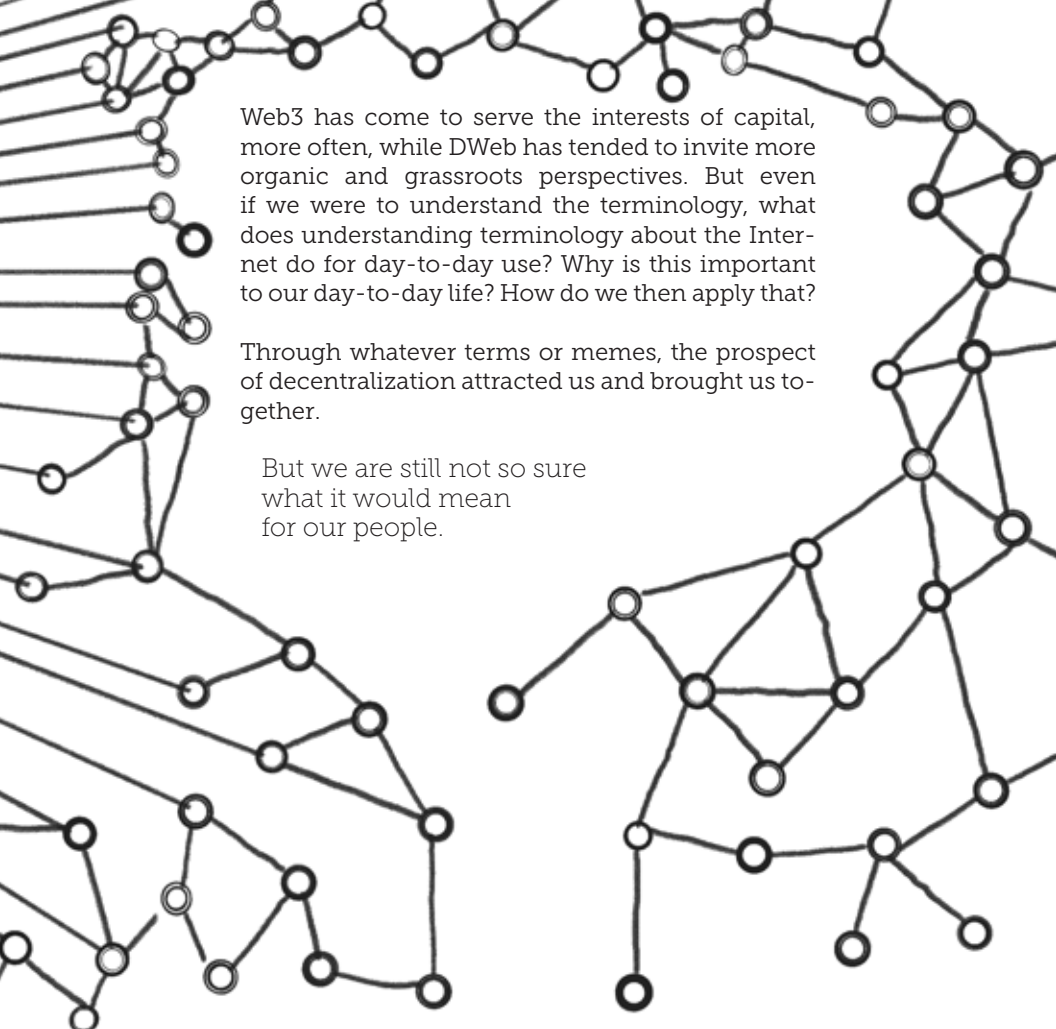

Web3 has come to serve the interests of capital, more often, while DWeb has tended to invite more organic and grassroots perspectives. But even if we were to understand the terminology, what does understanding terminology about the Internet do for day-to-day use? Why is this important to our day-to-day life? How do we then apply that?

Through whatever terms or memes, the prospect of decentralization attracted us and brought us together.

But we are still not so sure what it would mean for our people.

---

**Collaborative wikis** invite people to produce shared stores of knowledge through open authoring and editing. These are designed for slow evolution, one user at a time.

- *example*

**\$ DokuWiki, GitBook, MediaWiki**

> The goal of our wiki is to collect information about the diversity of bees in the Amazon area. A normal beekeeper has native and other bees and has to keep track of where they are located. I guess never had a wiki before—so yeah, it's quite a challenge, and I'm a little bit worried about it.

- Ana Rosa de Lima (Meli Bees Network)

---

*~/Tool/Collaborative wikis*



The trouble with relying too much on decentralization as a load-bearing concept is that, when you apply it to one thing, its opposite appears very nearby:

- Blockchains decentralize control over a money system, but centralize by relying on a protocol that everyone must use for them to work
- Cash decentralizes by allowing untraceable activity at the margins, but it centralizes with a monopoly on printing and issuance
- Email decentralizes by enabling anyone to run a server and send messages to people on any other server, but it centralizes when just a few companies control the management and surveillance of messages
- Antitrust law decentralizes by preventing a corporation from monopolizing a whole market, but centralizes by holding its own monopoly over powers to regulate
- Solar panels decentralize by enabling people to run their own power plants, but centralize by pointing them all at one Sun

*I want to work on a peer-to-peer basis that gives ownership to communities, while allowing them to interact. I don't know how best to collect and release information about biodiversity. There are many ways it could go. But making sure they have ownership—that's my goal.*

— Ana Rosa de Lima  
(Meli Bees Network)

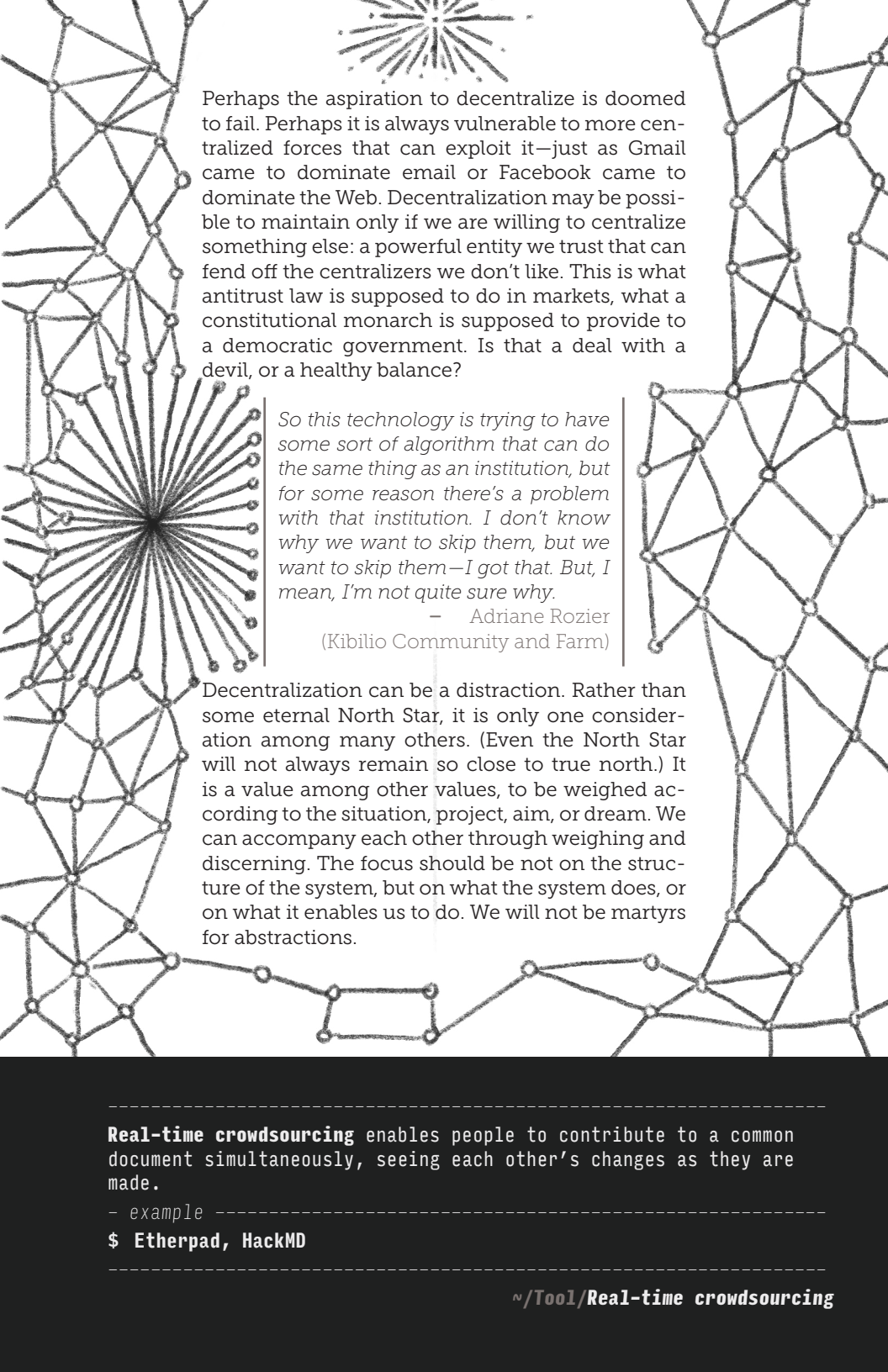

Perhaps the aspiration to decentralize is doomed to fail. Perhaps it is always vulnerable to more centralized forces that can exploit it—just as Gmail came to dominate email or Facebook came to dominate the Web. Decentralization may be possible to maintain only if we are willing to centralize something else: a powerful entity we trust that can fend off the centralizers we don't like. This is what antitrust law is supposed to do in markets, what a constitutional monarch is supposed to provide to a democratic government. Is that a deal with a devil, or a healthy balance?

*So this technology is trying to have some sort of algorithm that can do the same thing as an institution, but for some reason there's a problem with that institution. I don't know why we want to skip them, but we want to skip them—I got that. But, I mean, I'm not quite sure why.*

— Adriane Rozier  
(Kibilio Community and Farm)

Decentralization can be a distraction. Rather than some eternal North Star, it is only one consideration among many others. (Even the North Star will not always remain so close to true north.) It is a value among other values, to be weighed according to the situation, project, aim, or dream. We can accompany each other through weighing and discerning. The focus should be not on the structure of the system, but on what the system does, or on what it enables us to do. We will not be martyrs for abstractions.

---

**Real-time crowdsourcing** enables people to contribute to a common document simultaneously, seeing each other's changes as they are made.

— example

\$ Etherpad, HackMD

---

~/Tool/Real-time crowdsourcing

## "AI" Reply

*Decentralization can be a powerful tool for creating more equitable communities, especially for those marginalized by existing power structures. By distributing resources and power more evenly, it can help to create a more level playing field and ensure that everyone has a voice. Decentralization also offers communities an increased level of autonomy and freedom, as it rests on the principle of self-governance. In order for a community to be able to make decisions for itself and take control of its own destiny, decentralization is essential.*



There are times when it makes sense to nudge each other toward choices that decentralize power in the places where power should not accumulate. In an economy built for centralized power, that may be challenging in the short term. The tools may be harder to use at first, because they do not have companies investing vast resources to make them easy. People lose the muscle-memory for self-governance when they are not used to practicing it. But we help each other where we can. We can turn those challenges into excuses for being together as we need to be.







# COVENANT

*Many innovators who are leading communities of care are hungry for insight and wisdom and practices from our most ancient traditions to do the work that they're doing. There has been an accrual of wisdom that was kind of housed in all of our religious traditions. And yet many people are cut off from them, for various reasons. Some of which I think are very good reasons. But there's still a hunger for what's held in those traditions.*

– Angie Thurston  
(Sacred Design Lab)

We started our time together by making a covenant. It drew from several sources, from communities we had been part of or heard of. It started with the things we aspire to and ended with the things we will not tolerate, that we promise to protect each other from.

Do you have a covenant? Do you have stories or lessons you tell again and again? Stories from your ancestors that you will tell again to your descendants?

What we did not do so well was repeat our covenant to each other. We did not incorporate it into ritual. We left it there as a document in the background, on our private forum, as if documents resting unused on a server's hard drive have life. They live only if you visit them and give them some honor.

This is what many traditions of covenant do. The wampum belt tells a story only to those who have heard it told. The Benedictine nuns and monks read their Rule to each other over meals. Each year, a calendar

is a sequence of reminders of what its community has agreed to.

*We have an affordable home community, and we need to set up some rules that people have very strong opinions about. And so, how do we survey what people want for rules without influencing the outcome? And I am trying to avoid those big opinions coming out as, Oh, it cannot be this way! We're still struggling with our park rules. There is this scary dark place to go to for getting those rules in place.*

– Peggy Kuhn  
(Sans Souci Cooperative)

*There's a particular focused research project that we undertook during the last year, and this has to do with trying to articulate and reassess and codify some of the priorities that define us. It is an inversion of the "terms of service," the contracts that we often are inundated with when we're spending time online. Those are not consensual, truly, and are not really a choice, you know. We wanted to push against that. It was an open research process, and went on for weeks, on how we think about space and access and intimacy. It led us to thinking about our community spaces online and what makes a great place to hang out and what makes people feel safe and welcome.*

– Sara Suárez and Alice Yuan  
Zhang  
(virtual care lab)

Rules do not make a community. They are an out-

line or a shell, a skeleton or a wireframe, a guard-rail but not the road. Not even the foundation. Not the parachute. The ceremony site but not the dance. Think 20 percent rules, 80 percent culture and practice and relationship, if we grant rules even that.

*I would describe a covenant as a sacred promise that people make to each other, as well as a practice of referencing those promises as the center of our life together. Agreements aren't that relevant if we can't even find them and don't know what they are, so it's really important that covenant is both a noun and a verb, both the content of the promises and the practice of living into them.*

— Angie Thurston  
(Sacred Design Lab)

Covenants help communities know who they are and how they work. They are walls and ramparts when we need them, permeable but protective. When communities know who they are, and know how to govern themselves, the harder they are to govern for somebody else.



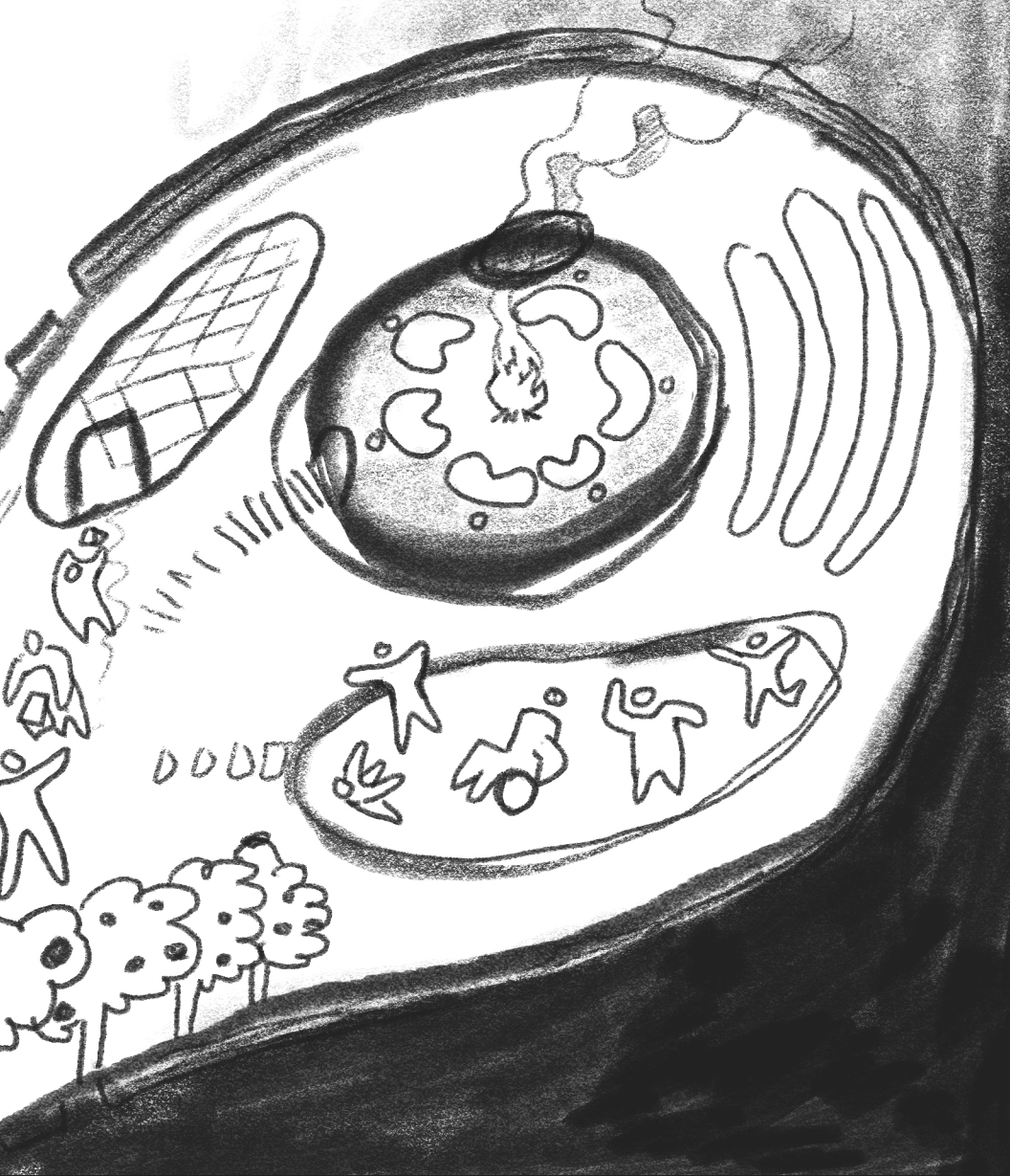

---

**Fiscal hosting** means having a trusted organization manage a community's interaction with the legal and financial systems. This means the community can have the benefits of legal recognition without bearing many of the challenges.

- example -

\$ Fractured Atlas, Open Collective

---

~/Tool/Fiscal hosting





**STACKS** FOR WHOM?

The Internet has become the fabric of society. There are communities that don't have direct access to the Internet, but their people's lives are still affected by it. Not everybody is going to be in the metaverse—whatever that is, or whatever it will be—but the metaverse will affect everybody.

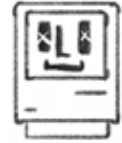
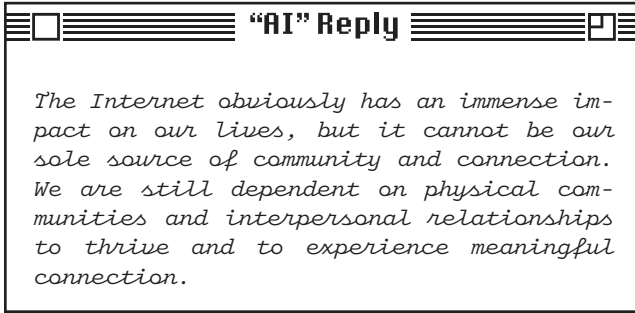

The people who are supposed to need decentralized technologies most, whose lives are most beset by the abuse of intermediaries, are those least likely to be found asking if they can pay you for that with Bitcoin or the like.

Decentralized technology was supposed to enable:

- A renaissance of democracy
- Easy cross border payments to correct global wealth inequality
- Financial services for the unbanked
- Benefits of citizenship to stateless refugees
- Circumventing censorship by authoritarian regimes
- Technology funded by users, not investors
- Coordination on problems governments have been unable to solve

But for a lot of us decentralized tools are actually just strange and hard to use and confusing. Because of that very little of the above gets done.



How do we make these things more applicable to a daily practice, as opposed to being merely a conversation that is going on in tech circles?

*I've had a lot of resistance to using virtual spaces. One time I tried to plan a convention for my union, and I proposed using a virtual space, and people were very resistant. I think people have just a general fear of technology or of using something new. They don't know how to use it. It's not that complicated. But I think people just get freaked out.*

— Shoshana Brown  
(Kibilio Community and Farm)

*I face a lot of challenges with having time. Most of our time is spent in ongoing meetings about fixes to frozen pipes, or helping replace roofs and getting city or county support to help those who cannot afford to fix their homes. Creating our own server—it just seems daunting right now.*

— Peggy Kuhn  
(Sans Souci Cooperative)

The Internet is not as uniquely complicated as some would have it seem. Is it more complicated than a pozole or a quilt, a rice terrace or a steel mill, an ancient ceremony or a great novel? There are many parts of it, yes. There are many specialized terms. In learning it, people have had to neglect learning other skills. In pursuit of a certain seamless “user experience,” companies insist that their technology is something mere mortals cannot grasp. Devices and apps once came with manuals, under the former assumption that users could and should learn some-

thing to use them. Now mystification reigns.

Industrial magic, the rounded corners of casing around the hard edges of circuit boards, the apps that claim “anyone” can use them, the “digital natives” who can use them but are not taught what lies beneath.

This is mystification: *You couldn't possibly understand. This is not for you.* But the sacred can mystify, too.

In this way a community can take a pack of cigarettes, bought in a box at a store, and make it no longer a product—it becomes the sacred plant, the ritual object, the site of meaning that outsiders no longer know how to use properly. The sacred stack

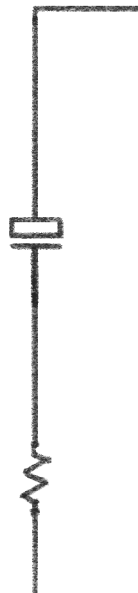
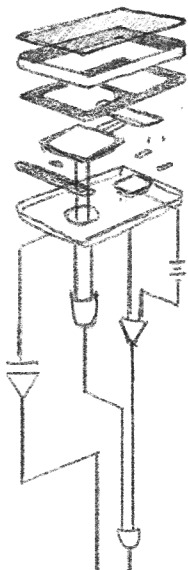

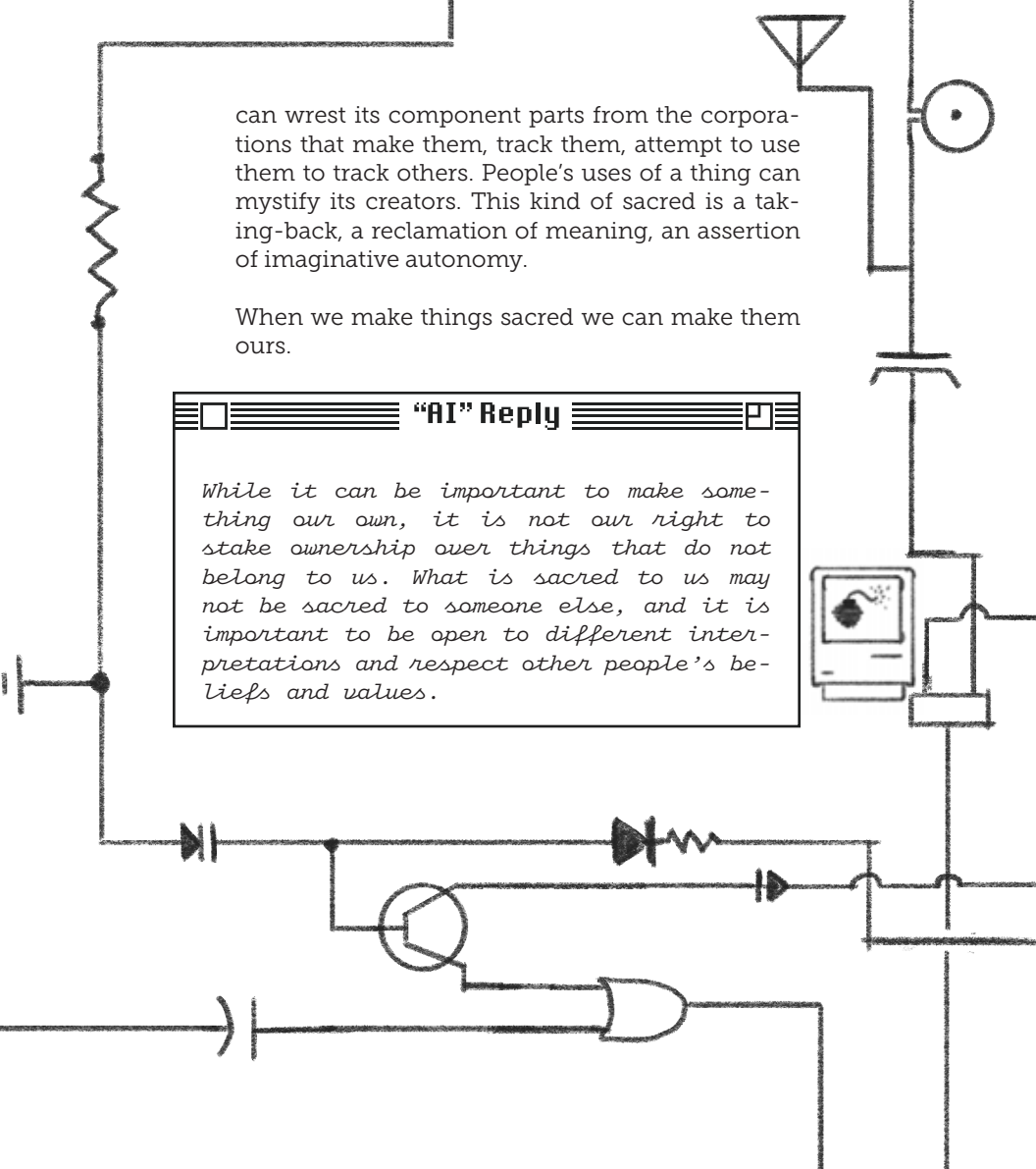

can wrest its component parts from the corporations that make them, track them, attempt to use them to track others. People's uses of a thing can mystify its creators. This kind of sacred is a taking-back, a reclamation of meaning, an assertion of imaginative autonomy.

When we make things sacred we can make them ours.

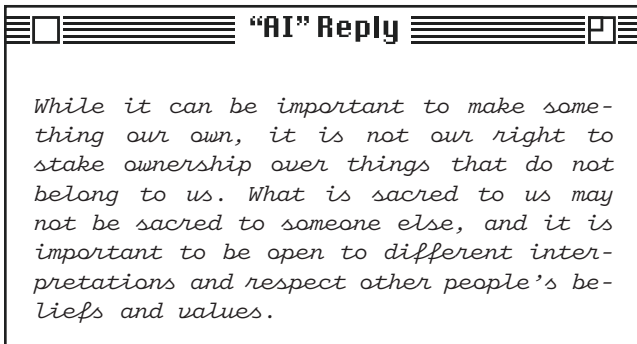

---

**Decision-making tools** are designed to help communities coalesce around agreements, rather than encouraging the endless chatter and conflict of commercial social media. These tools may offer a variety of options, from majority voting to delegation and consensus processes.

- example

\$ Decidim, Loomio, Snapshot



**ADOPTION**



**CO-OPTATION**



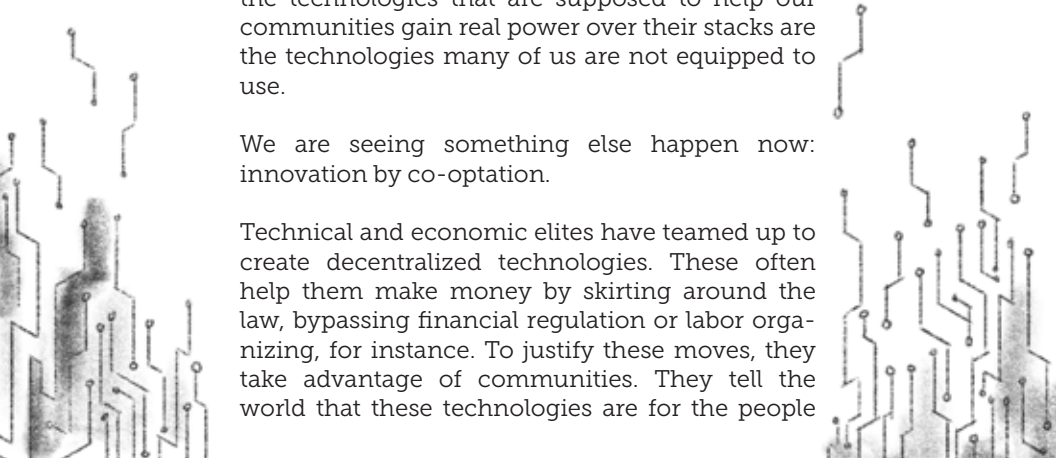

The spread of new technology used to be described as “diffusion”: it starts with some elite, and then makes its way across society. Others have emphasized how much innovation is “user-led”: first it comes from user communities, then corporate elites adopt it and commercialize it only later. But what we experience today is something else: the technologies that are supposed to help our communities gain real power over their stacks are the technologies many of us are not equipped to use.

We are seeing something else happen now: innovation by co-optation.

Technical and economic elites have teamed up to create decentralized technologies. These often help them make money by skirting around the law, bypassing financial regulation or labor organizing, for instance. To justify these moves, they take advantage of communities. They tell the world that these technologies are for the people

---

**Transformative justice** involves addressing conflict and harm through collaborative processes among affected people, without resorting to retributive punishment. The process involves not only the people directly involved in a case of harm but also the community whose structures may have encouraged it.

— *example*

---

### **\$ Creative Interventions, One Million Experiments**

---

> Ten years from now we’re looking at a community where the idea of prison is not the concept anymore. If I have to be removed from society, it is because I need to be healed. Not long ago I did a presentation in Las Vegas at a Star Trek convention. The title was “Reimagining Systems of Justice.” And what I found rather shocking is that the large majority of the people in the crowd were not even familiar with the idea of restorative justice or transformative justice. Their ideas of justice were strictly based on the theories that are communicated in the academy around what justice means in the judicial processes, and that’s so divorced from and devoid of the people who actually experience those systems.

— Rahim Buford (Unheard Voices Outreach)

---



struggling for survival and justice, and that is why circumvention is needed. But we didn't build the tools or design them. When we try to use them, they do not make a whole lot of sense or work the way we need them to. They were made in our name, but not actually for us. Meanwhile, the elites win power and influence by breaking society's rules, all while repeating the story that it is for our benefit.

### "AI" Reply

*Though there may be elites who use decentralized technologies to exploit others, there are also many who are using them to build more equitable and just societies. Decentralized technologies enable people to make their own choices, exercise more self-determination, and be part of a more transparent and accountable system. Moreover, these technologies can be used to support grassroots organizing by giving people a platform to organize and share their stories, which can lead to greater social awareness and social action.*

As his cryptocurrency exchange FTX was collapsing in November 2022, cryptocurrency mogul Sam Bankman-Fried admitted to a reporter that he had been party to "this dumb game we woke westerners play where we say all the right shiboleths and so everyone likes us" [sic]. Meanwhile he defrauded billions of dollars from people he courted in Super Bowl ads.

"Early adopters" are the lionized pioneers, the brave souls willing to take up a new technology before it fully works, to be the test cases and shape it. But early for what? Is the trajectory foreordained? And adopting what from where? Is adopting a device like adopting a child? Is adoption a responsibility or a privilege? Does it present itself that way? Are the adopters vetted? Do we know we can trust these people to decide what works, what features they need or dislike? Should they have to pass a test or be subjected to interviews? The hope and the danger is that they will fall in love with the

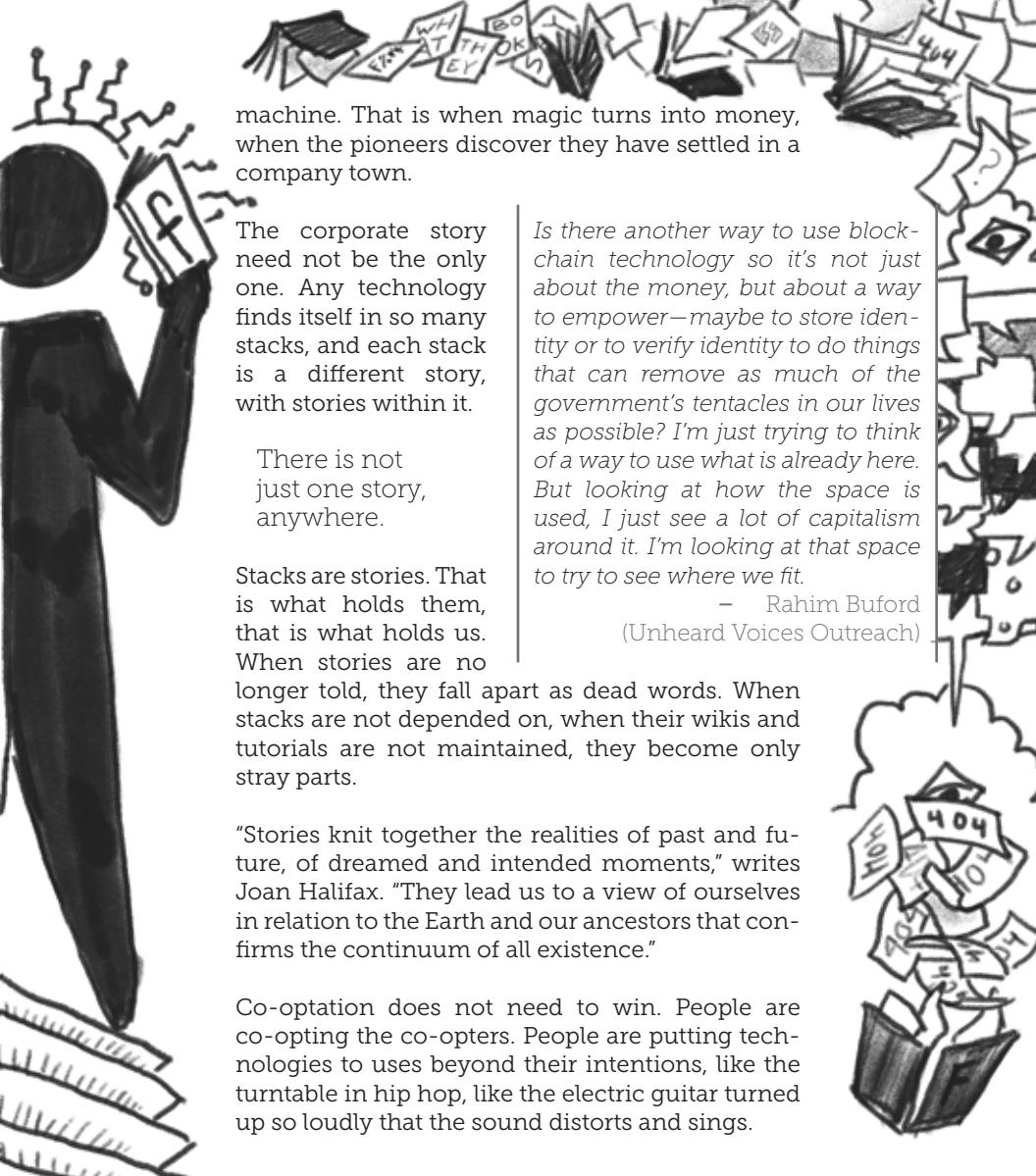

machine. That is when magic turns into money, when the pioneers discover they have settled in a company town.

The corporate story need not be the only one. Any technology finds itself in so many stacks, and each stack is a different story, with stories within it.

There is not just one story, anywhere.

Stacks are stories. That is what holds them, that is what holds us. When stories are no longer told, they fall apart as dead words. When stacks are not depended on, when their wikis and tutorials are not maintained, they become only stray parts.

"Stories knit together the realities of past and future, of dreamed and intended moments," writes Joan Halifax. "They lead us to a view of ourselves in relation to the Earth and our ancestors that confirms the continuum of all existence."

Co-optation does not need to win. People are co-opting the co-opters. People are putting technologies to uses beyond their intentions, like the turntable in hip hop, like the electric guitar turned up so loudly that the sound distorts and sings.

*Is there another way to use blockchain technology so it's not just about the money, but about a way to empower—maybe to store identity or to verify identity to do things that can remove as much of the government's tentacles in our lives as possible? I'm just trying to think of a way to use what is already here. But looking at how the space is used, I just see a lot of capitalism around it. I'm looking at that space to try to see where we fit.*

— Rahim Buford  
(Unheard Voices Outreach)

---

**Ethical hardware** offers users computing technologies that may be less harmful from the perspective of labor practices or environmental impact. This may involve carefully chosen supply chains, or even just making machines more easily repairable, thus extending their working life and reducing the need for replacement.

— example

\$ Fairphone, Framework, Teracube

---



Friction as a Teacher

FRICION  $\Delta S \Delta$  TEACHER



The people who design products for the Internet worry about what they call *friction*. Friction is the extra click, the source of confusion, the time necessary to learn. Designers seek to minimize it, so that there are as few barriers as possible preventing the flow of revenue to their employers. All of it is a target. All of it is trouble. Entire industries exist to shave milliseconds from the flow of data from servers to browsers, out of the justified fear that any latency will cause users with endless choices to flit their attention elsewhere and redirect the flow of money.

What if, in contrast to the product-builders, we treat friction as a teacher? If an app takes time and support to learn, that friction is an opportunity for in-person mentoring sessions that can bring a community closer. If sending a message out to the world takes more than a click, perhaps the senders will sit with the message longer and make sure it is what they really want to say. If there is a language barrier for one

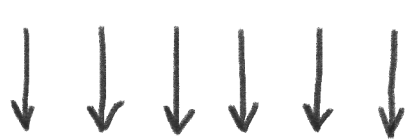

*With Google Workspace we had an individual account, and it was difficult traversing through the files and not understanding typical Drive sub-folders. I'd upload a document, and it would change the format. I tried to make everything up on one page, and it would roll to the next. It's stuff like that until I started using LibreOffice, but that was a suggestion from somebody else, because I didn't understand what was happening. I started putting things up as a PDF, but then people couldn't comment or make changes on Google Docs. And so it was a struggle for me. For a long time.*

— Peggy Kuhn  
(Sans Souci Cooperative)

*Yesterday we had to focus on members who weren't able to even open a link in an email. One person asked me to help. I work with her one-on-one here in New York. She wants me to meet her in Brooklyn and walk her through Google Sheets and things like that. It's kind of hard for me. I'm really busy right now. Another person has a language barrier, so he spends a lot of time with Siri and Google just trying to translate. If you're a teacher and have a second-language learner in your class, they're trying to translate all the time. You're wondering, are they really keeping up with what new things are coming in? Because they're so busy trying to translate what happened before.*

— Adriane Rozier  
(Kibilio Community and Farm)

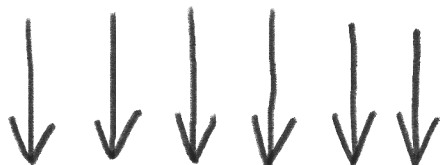

person, it encourages everyone to slow down and choose their words more carefully.

As the Nigerian thinker Bayo Akomolafe says, "In distressing times, sometimes a solution is count-

*There's always a context to whatever you're trying to communicate, and that often is unspoken. Sometimes that context is the surroundings. But sometimes there's another reason. If you're miscommunicating both online or in person, there's some underlying reason why. Email, for example. I get mail. I open it. I read it. I deal with it. But if someone's not doing that, why? We have to decide if we want to address it or not. In this day and age, we can have the best communication tools in the world, but it doesn't mean people will understand each other. That's what I'm always trying to figure out. What's the context here? Why are people miscommunicating both in person and online?*

— Adriane Rozier  
(Kibilio Community and Farm)

er-productive, not the thing we might want to seek out." We can stay with the trouble, with the cracks, fissures, and wounds in order to precipitate the natural course of action of things, letting things fall apart. Then we can work our way out using that sensibility of the minimal, the crack, the lyrics of the imperfect to build something else.

Akomolafe reminds us of an African saying that wisdom springs from the corners of the mouth. We have been listening to an ideology that speaks

only from the center of its mouth, that seeks the comfort of the highway instead of the humility of the dirt road. Perhaps our technologies, despite the boasting claim of innovation and transformation, suffer from an inability to look from the sides, to refuse the hegemony of the straight path. There is perhaps more to learn from the toxic wasteland of Agbogbloshie in Accra than in the so-called "genius" centers of innovation in Silicon Valley. Seeing the latter as the avant-garde archetype of technique and the former as a paralyzed victim of imperial opulence is the source of our ignorance.

Friction can reveal the biases built into a society and its technology. If opting into surveillance is easier than choosing privacy, that is a lesson. Why is that? How did it get that way? If ordering a spare part is easier from an exploitative corporation than from a local store, why is that? Could the friction

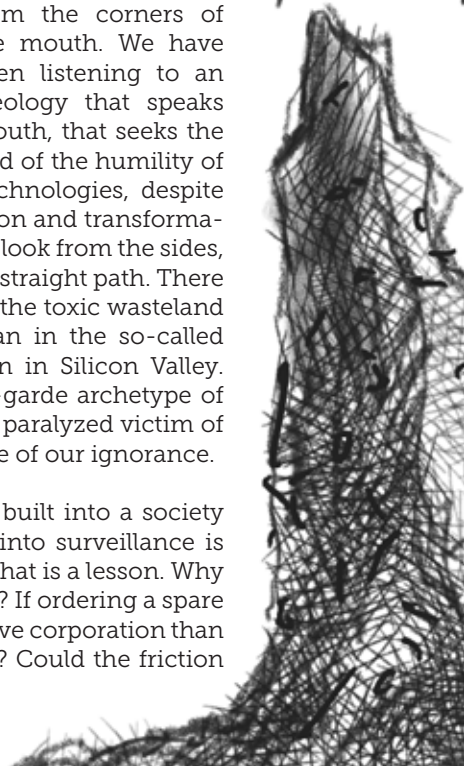



in our lives—and there is always friction somewhere—be organized differently? Friction can be something we love.

Friction is what keeps  
a bicycle upright and steady,  
what keeps a foot  
from slipping on ice.

Friction is how a flute  
turns wind into a note,  
how a finger  
pulls a string to sound.

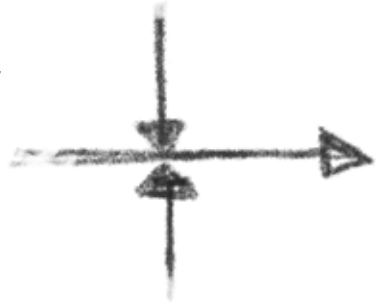

There is friction in the work that commercial technology hides from view—the glitches and the testing, the honing and improving, the humans subjected the worst images others can conjure, the patterns of thinking that hide beneath an interface. What if these labors were more widely shared?

A sacred stack seeks to distribute its friction on its own terms. Its community wants to participate in its troubles and its learning. Communities use friction as a chance to come closer together.

Friction opens time for the sacred. That is where the sacred takes hold in us—in the friction. How we choose to use friction can make it sacred and make it ours.

*A new co-op member volunteered to clean out the crawlspace of our oldest resident, who has lived in the park for fifty-two years. She is one who has come out whenever we've had volunteer work days. She's a helpful person herself. Unfortunately, raccoons had lived under her home for about twenty-five years. The poop and the mess was hazardous work. Her pipe needed replacement, but the plumber did not want to come out in those conditions, after he saw under her home. This woman had been living now for about a month without running water in her home. So our volunteers put on suits and were almost totally brown when they finished the job.*

— Peggy Kuhn  
(Sans Souci Cooperative)

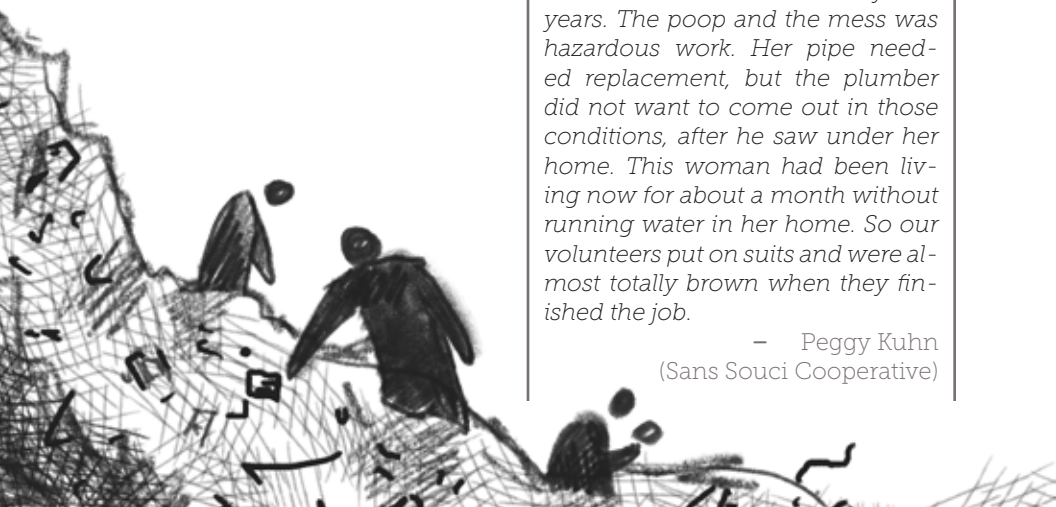









---

**Licenses** allow creators to decide how their works may be circulated and used. Creative licensing has produced large pools of free, open-source software, and innovators are beginning to explore using them to protect human rights and support equitable economies.

- example -

\$ Creative Commons, Organization for Ethical Source,  
\$ Peer Production License

Circular

NOVELTIES

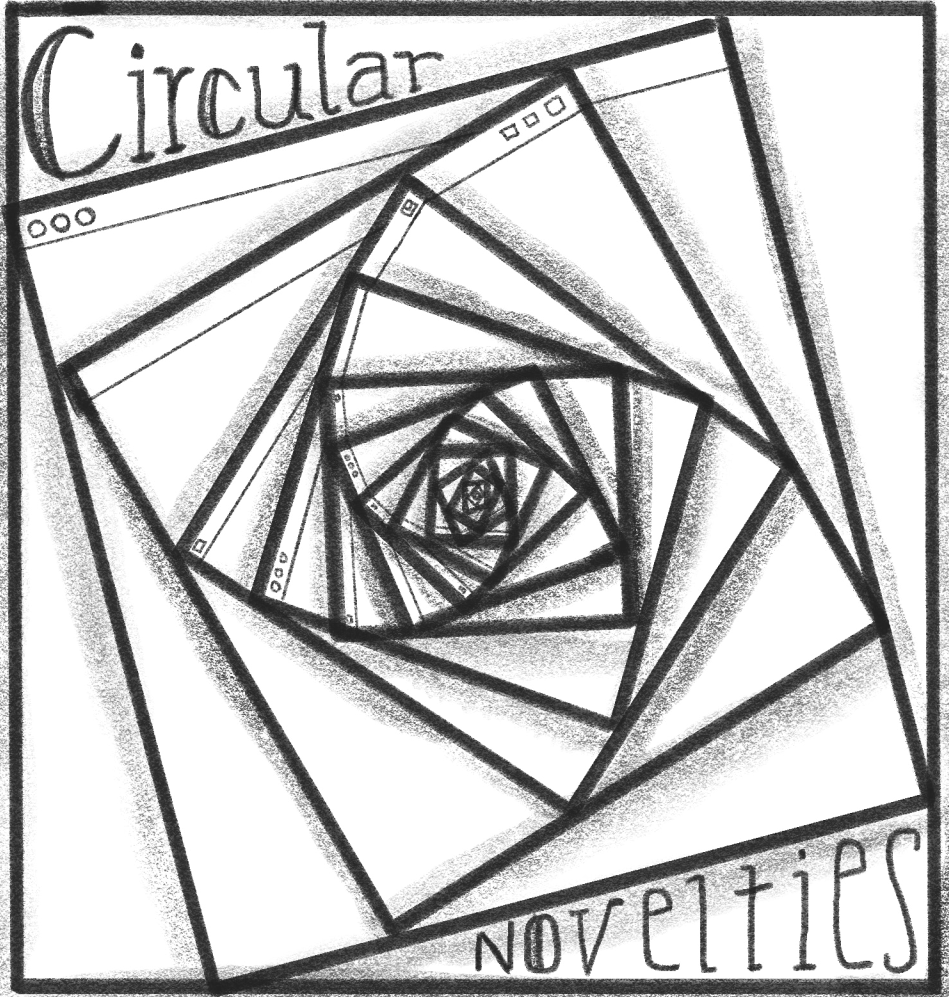

Before the Internet, the first online social networks were bulletin-board servers, often sitting on a machine in someone's home. What people found in each other there was liberating or revealing. But a lot of the chatter in those days, from the 1970s into the early 1990s, was a matter of marveling at the technology at hand, or asking advice about simply getting the stuff to work. Many of those people believed that the systems they were building would someday remake the world, and few people outside their worlds believed them. Here we are.

The anthropologist Christopher Kelty has described the communities that form around some emerging technologies as "recursive publics." They are recursive in that they refer back to themselves. The community exists to build the stacks that form the basis of that community. The value to the world outside is questionable, until one day there is no world outside, because those stacks have become the measure of the world.

We might ask, *What good is it for? What will it do for our people?* The trouble is that the answer may only come

by not asking those questions  
and sharing life with the stack  
not knowing the answer  
but discovering each other  
—communities and machines—  
together.

The early adopters take pleasure in their machines. Too much maybe, maybe veering on idolatry. Perhaps they can enjoy a useless machine only because of some privilege that others lack. But every great machine begins as a mystery, for which the world is not ready, which is to say that it is useless.

What do we ask of our technology? Through the circularity of a not-obviously-useful relationship with machines, communities can find new life. The machine can be more than a means toward an end, a mere mode of communicating, and become a distinct way to participate in community. We can make the circular our own. This interrupts other visions of technology as ancillary to what the community does, or as a Band-Aid to fix some



*At this time we're deciding just to go with things that people know and developing their skills. I think that people like their certain kinds of communication, and are probably going to stick with them. Each tool has its own little learning curve.*

— Adriane Rozier  
(Kibilio Community and Farm)

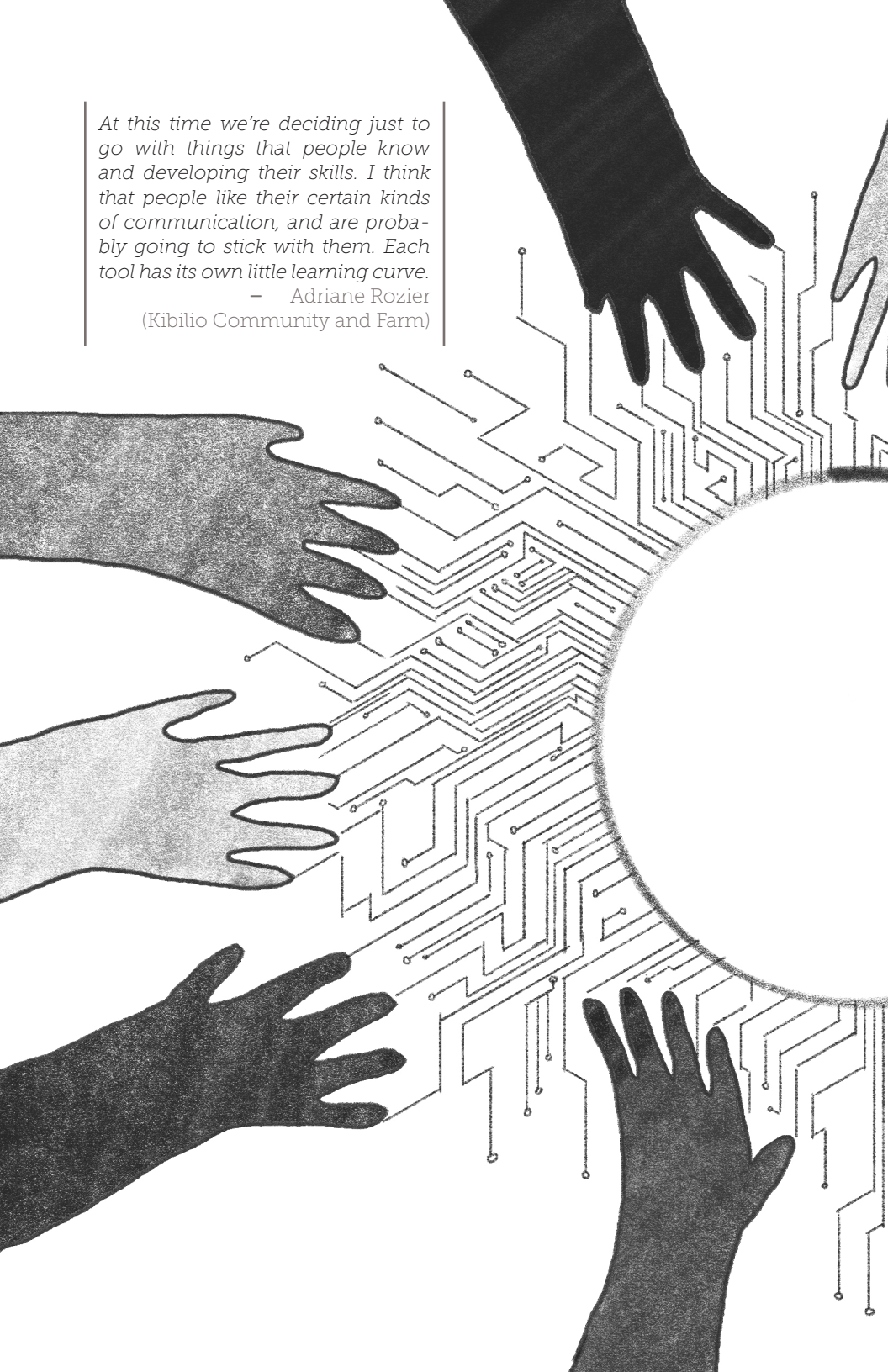

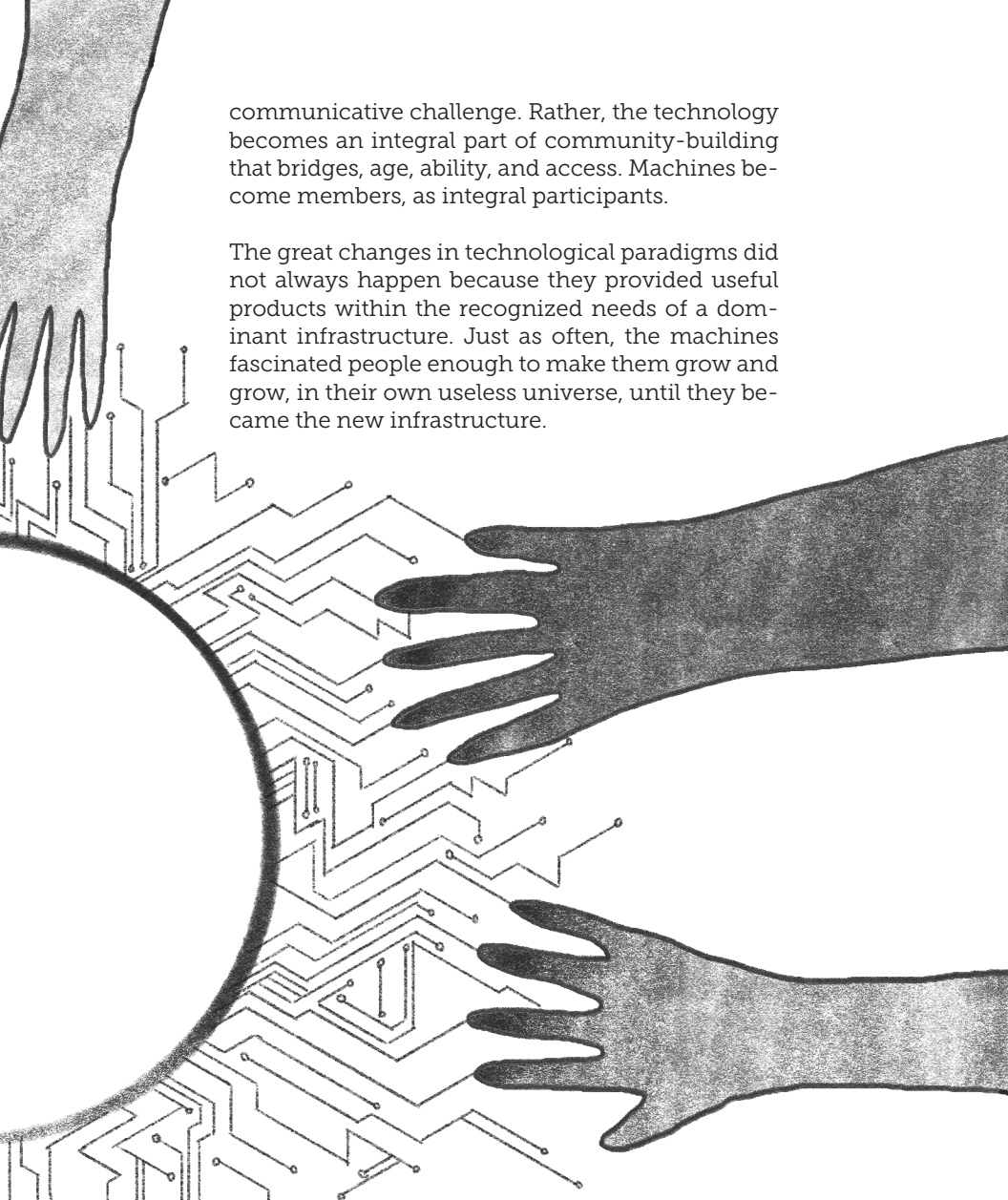
An illustration showing two hands, one above the other, reaching towards a complex circuit board. The circuit board is filled with intricate lines and nodes, representing a network or infrastructure. The hands are rendered in a dark, textured style, suggesting a human presence interacting with the technology. The overall composition is split vertically, with the hands on the right and the circuit board on the left.

communicative challenge. Rather, the technology becomes an integral part of community-building that bridges, age, ability, and access. Machines become members, as integral participants.

The great changes in technological paradigms did not always happen because they provided useful products within the recognized needs of a dominant infrastructure. Just as often, the machines fascinated people enough to make them grow and grow, in their own useless universe, until they became the new infrastructure.

---

**Cobudgeting** is when communities allocate scarce resources, particularly money, in a collaborative way, enabling any member to participate and help identify worthy uses.

- example -

**\$ Cobudget, Gitcoin**

---



THE



CADENCE



OF



CHANGE

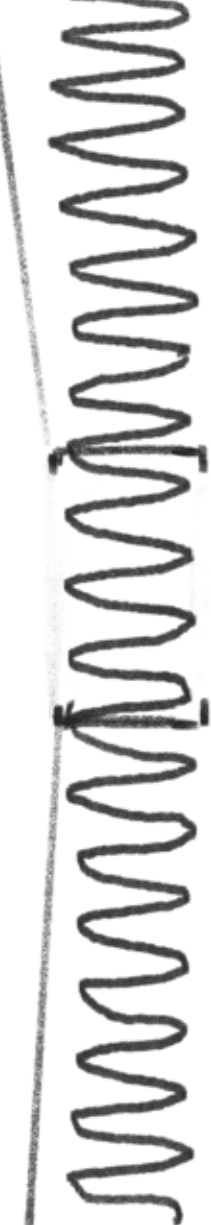

People say that patience is a virtue. But how true is this in these days of frenzied acceleration, as we hurtle toward some uncertain future? Technological products increasingly come freighted with built-in obsolescence. They and we are quickly out of date, yesterday's news, scrambling for patches and upgrades. Yet the systems we are working to dismantle, transform, and revive move at an entirely different cadence: years, decades, spent building communities of solidarity; generations of harm and marginalization to undo and repair. How do we keep up, stay on top of the next and the latest, while also continuing to slowly untangle the knots of unjust relationships? More concretely, how can we write a guide to decentralized tools while the topic shape-shifts from a vaunted promise to a Ponzi scheme within a week?

Shift the timeframe, readjust the cadence. Instead of viewing our time together as a "project," it became about reorienting the frame to a connected series of conversations, stories we are sharing about how we work and the tools we are using to create change—small and great—in the lives of

*Right now, financially, we don't have what it's gonna take to bring the people together. But I really believe there are some gracious individuals who don't need money but want to participate in something like this to see people like myself have a fair chance at a second chance. So, it's creating clarity, a good plan. I know it's not gonna happen any time soon. And I'm okay with that."*

— Rahim Buford (Unheard Voices Outreach)

our communities. Sacred stacks are less about doing things with a certain tool set than about being with other people, honoring their truths and perspectives, and respecting the time it took to arrive at choices about their toolset. It doesn't need to be

---

**Speculative fiction** invites people to imagine radically different societies than what they presently inhabit. This involves not only alternative power relations but also technologies designed to serve needs others than those they presently serve.

— example

**\$ Emergent Strategy Ideation Institute**

---

~/Tool/Speculative fiction



the latest decentralized and philosophically correct tool; it just needs to work for that community.

The point is also not to simply hold on against change, as if you can stop it. The only constant in life is change, and our communities need to practice it. As Octavia Butler wrote in the scriptures of her Parable Series,

"All that you touch  
You Change.

All that you Change  
Changes you.

The only lasting truth  
is Change.

God  
is Change."



In the context of how technology has changed us, and how we in turn have changed technology, we can feel the truth that across time the only constant is change—and perhaps that change is sacred.

Maybe instead of switching from the rotary phone to the smartphone, we can open up that rotary one and get it to do something different. Maybe instead of buying new machines every few years, we put software on them that

*For our community, getting back to the spirit of community may mean getting back to in-person meetings. One of the hardest things for most residents to do is participate in meetings, and I believe the proverbial breaking bread together may work.*

— Juston Martin  
(Sans Souci Cooperative)

enables them to live longer. Maybe, rather than always marveling at the wizardry of the young, we ask our elders if they have done this or that, and adapt the better parts of those habits to new technology.

### “AI” Reply

*Change is not always positive and should not be embraced blindly. It's important to be mindful of the potential consequences of any change and be cautious about taking actions that could have an adverse effect. It's also important to recognize that change can be disruptive and overwhelming, and give people the space and time to process it.*



---

**Covenant** is the practice of making and maintaining a basic agreement for a community, such as a code of conduct or bylaws. More than a text itself, covenant involves repeating, refreshing, and enacting its meaning.

— example

**\$ CommunityRule, Contributor Covenant, Open Social Compact**

---

Time is circular as well as linear,  
slow at the same time as it is fast.

The landscapes change as we progress along a path, and stacks evolve. What works for an intimate community is not what will work for a place where many people find each other. The evolution may be sudden or incremental, intentional or so slow that people barely notice. Sometimes communities need to fork, to do mitosis, to break off copies of themselves that go another way. The ancestry that these departures carry is sacred, or can be. The lineage of forks and hacks is holy to those who remember them that way.

When we talk about change, we tend to look for outward change. The emancipatory logic of the sacred looks inward, never just outward. It is not about a performance or a claim of sacredness to reach some ends. It is about the means. The technologies at hand come with high barriers to entry and often reek of particular types of privilege, along with the demand to keep up and to always accelerate. But the sacred involves finding our own temporality. The sacred is learning what matters to our communities and honoring the space of connection, intimacy, wholeness—so when our practice moves outward it can be stronger.

Plan to evolve, plan for unexpected change. Build on a foundation prepared for change. Establish terms for how it happens. Practice change.

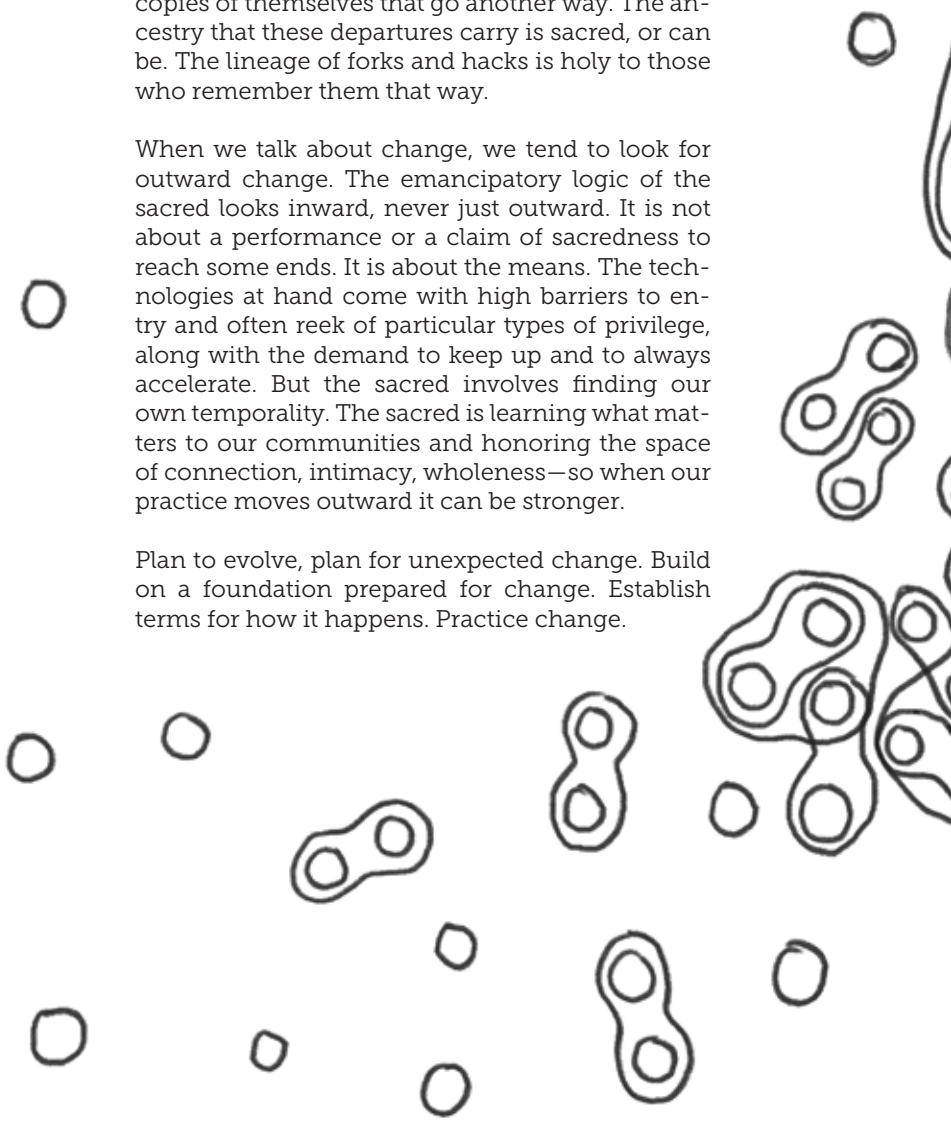

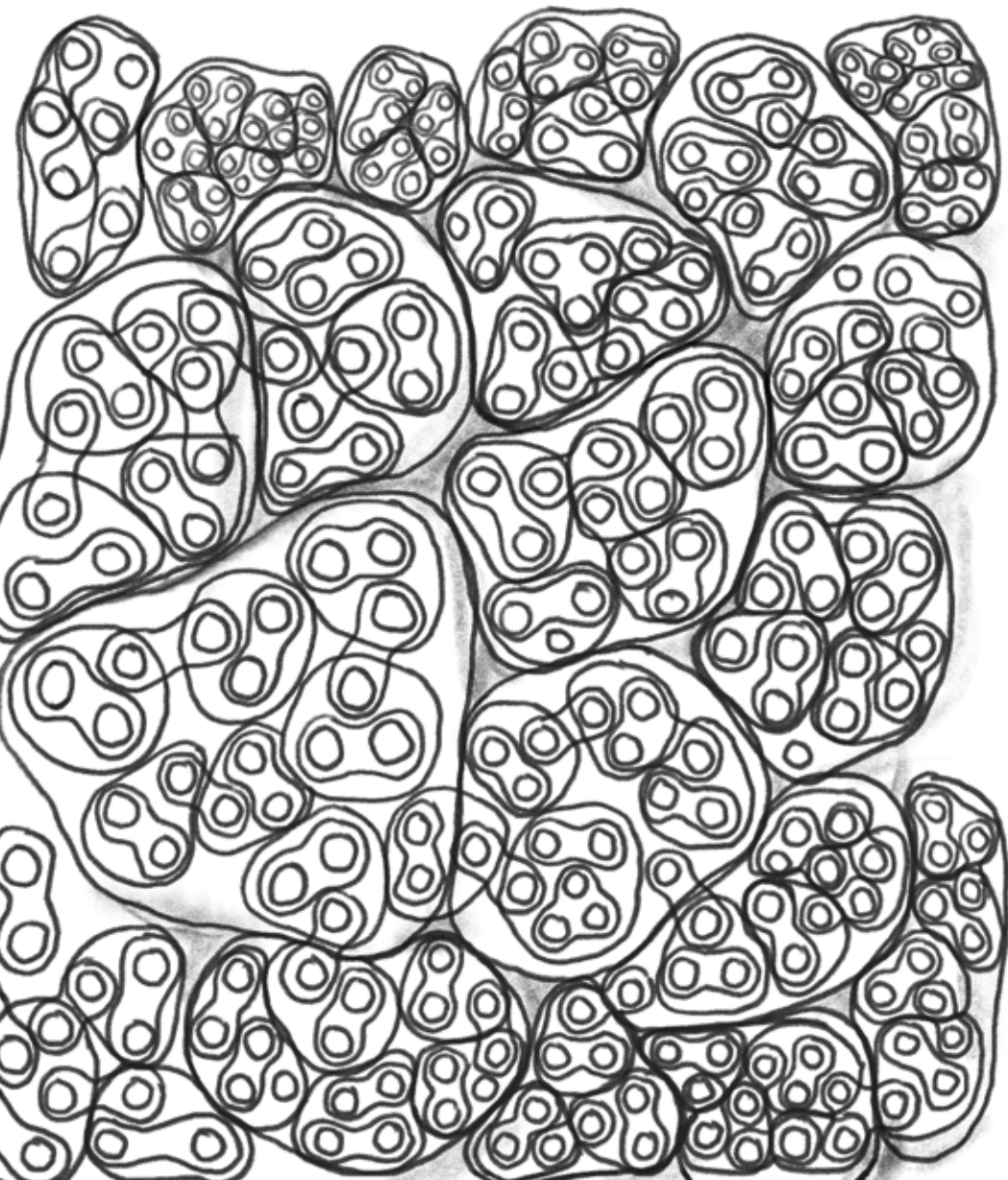

---

**Decentralized storage** spreads digital content such as websites and files across a network of computers, rather than relying on just a single server. Digital hosting need not be a matter of hoarding and owning; it can be a shared responsibility.

- example -

\$ **InterPlanetary File System, Filecoin**

---

~/Tool/Decentralized storage





ENVISIONING

ELSEW HERES

Imagination and speculative fabulation are critical today—engaging in a poetics of the what if, as we were taught by the writers Ursula Le Guin or Octavia Butler. “You can’t undo injustice,” Le Guin used to say, “if you can’t imagine it.” When our words, our experiences, and our tools do not cohere around our aspirations, we must engage in a battle of imagination because the imaginary of data grab, profit, and conquest has ruled us for far too long.

Looking elsewhere is vital, not to find some perfect, human-centered model, and not to romanticize the past or lock up wisdom in some bygone civilization, but rather to queer our agency and look again at life from the perspective of those who have been excluded from the hope of rights, of recognition, or of repair. Liberation is only possible through the undiscipline of their insurrection and of their ability to regenerate life in the thickness of cracks and wounds.

*I was introduced to Ursula Le Guin in prison. I think it was The Left Hand of Darkness that caused me to fall in love with reading again. I hated reading. But that took me on a journey. I'd never thought about a world where gender wasn't something that was two separate beings, but in that world were these androgynous figures, and it is so. That's what my hope is, the fiction of my imagination. White supremacy was a fiction that became Manifest Destiny. Recognizing that can help people understand how things came to be. It's actually the beginning of the creation of a whole new way of of existing.*

— Rahum Buford  
(Unheard Voices Outreach)

Imagination is the elsewhere of our moment, the offering of our times, and the labor we must reclaim. Our energy has been consumed by the compulsion to respond and react to the dominant technological order when we should be tending to our instinctive and nomadic desire to find other homes. The trouble is not with our technologies but with the stubborn singularity that defies the natural ecstasy of our plural existence.

We are entangled with technology; our stacks are one part storytelling, one part eye contact, one part cells on a spreadsheet stored on an aging laptop. They will be imperfect; let them. The dream of the gleaming machine hides the reality of built-in ob-

solescence, constant upgrades and no right to repair. Let us instead channel a bricolage of patched infrastructure and salvaged bits. If we're forced to

end our meetings after forty minutes, let's reclaim those other twenty for making tea, stretching, being present. What Margaret Atwood calls the "fallow state" of our lives, like land left fallow to rest for a later season, can also be part of our stack.

When considering the near-future of our digital lives, it's hard to avoid conjuring more of the same. More data harvesting, more targeted advertising, more conflict-stocking, more monopolization. Sacred stacks might keep the candle of a brighter future burning. In these nascent alternatives, we can see other ways of being in the digital. We can see technologies that start with people's well-being over corporate bottom-lines. To gaze into this flame is to imagine a path forward rather than endlessly looping around the same negative

*Social dreaming was another activity we did. That's a guided sharing session where people tell dreams that they've had in a circle format. We did that a couple of times with Zoom in a way that incorporated meditation. It was interesting because that way of sharing guides people to open up something that's very private and intimate, in a way that isn't about interpreting the meaning of it, or deciding what it means about you. It's really more about just sharing it together. That was quite powerful in shifting the space of a video call. You really notice people being more in their bodies—closing their eyes, looking away from the screen.*

— Alice Yuan Zhang  
(virtual care lab)

*I've always been a mystery reader, and I always think the difference between mystery and science fiction is that mystery readers are uncovering some injustice, and then working to expose it. Science fiction is imagining an alternative reality. I've been sort of uncomfortable with that, even though so much of my work has been around trying to imagine new systems.*

— JoEllen Chernow  
(Survivors Know)

spiral. Here we play with this vision and ask ourselves, what if the fire spreads? What if these sacred stacks proliferated so widely into the Web that, together, people could inhabit another way of being in cyberspace?

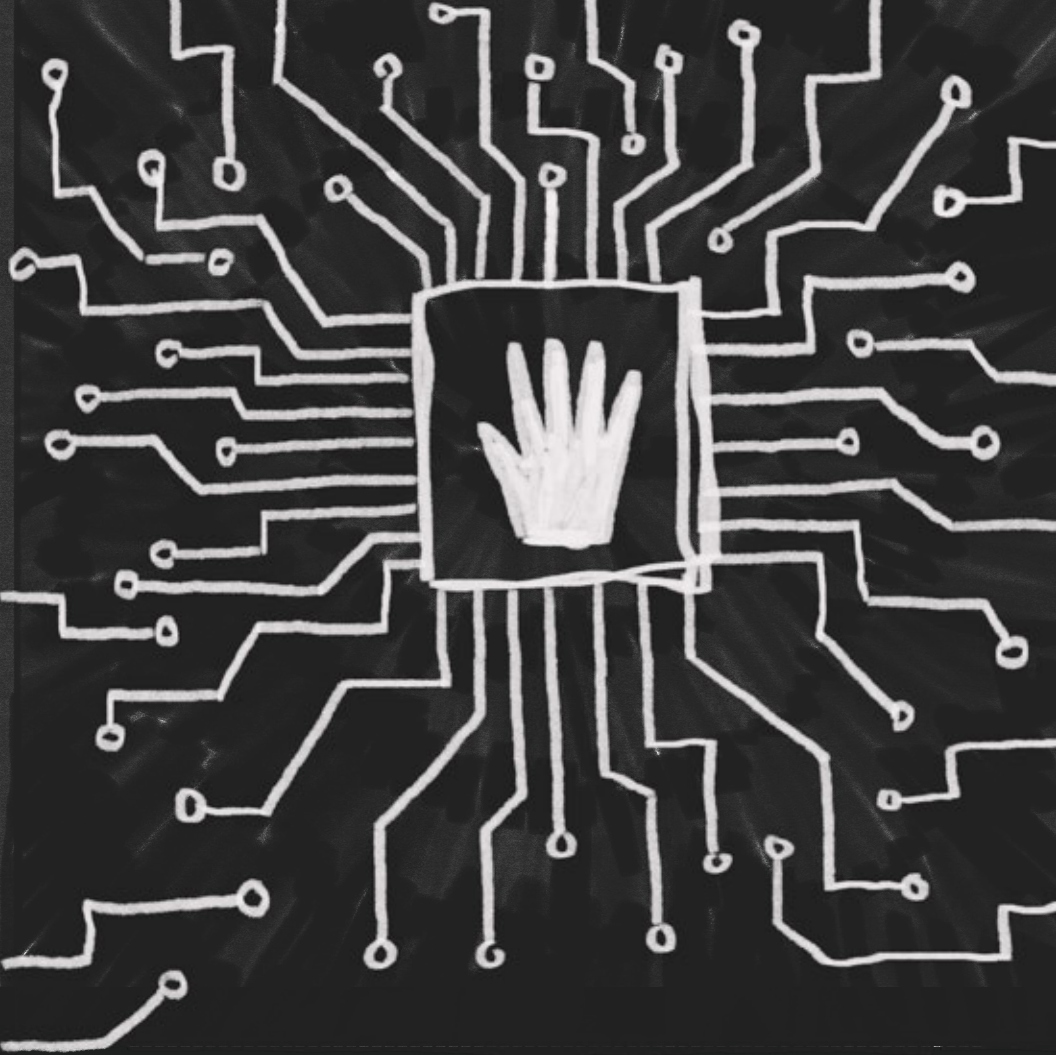

**Ritual** is a repetitive practice that reflects and carries out a community's most cherished values. It sets the tempo of time together and time apart, and it provides opportunities to step out of usual patterns and question them.

— example —

**\$ Librerating Structures, Sacred Design Lab, Microsolidarity**

> Something that's been really useful for us is what we call lab hour: a weekly, open, sort-of office hours or studio hours time, where anybody can drop into our Discord channel. That's been really successful. It has shifted from being a meeting to a place for people to be like, Who are you guys? What is this? It's really dynamic and strange.

— Sara Suárez and Alice Yuan Zhang (virtual care lab)



Imagine an elsewhere:



Representatives gather on a shared server. Today, deliberations begin on what will become the first digital constitution for netizens. Participants come from mutual-aid groups, decentralized social media platforms, gig-economy cooperatives, cryptocurrency networks, artist guilds, tech-unions, human rights organizations, and more. For years now, they have, in their own small circles, been building a new world with their communities. These collective practices have taught them all the strength possible in numbers.

*We envision a space where people are governing themselves, and people are creating for themselves, because the systems themselves are theirs. I guess that's pretty sci-fi in our current reality.*

— JoEllen Chernow  
(Survivors Know)

The first session begins with an invocation to guide the strenuous weeks, months, and years to come, when the participants all will clamor over visions, but all in the aim of the

common good. In the build-up to this event, factions formed along visions for how best to unite. As each representative gives their opening statements, they pronounce bold paths forward: *We need a common currency! Together, we have the means to provide our own universal basic income! We must enforce data standards for all our members! Before any proceedings may begin, a digital bill of rights must be established! This entire project is wrong! We cannot lose our independence to a new government!*



Worries set in among some that the demands are too conflicting, that louder voices are drowning out diverse perspectives, and that too much of the old way of doing things is present to ever enable something new. But the first convention came to close with resolutions most could live with, at least until next year's second round.

Representatives go back to their communities and get to work on new collaborations. Data stewardship is standardized for the first round of an opt-in data union. Individuals and communities earn a share in the value their data exhaust generates.



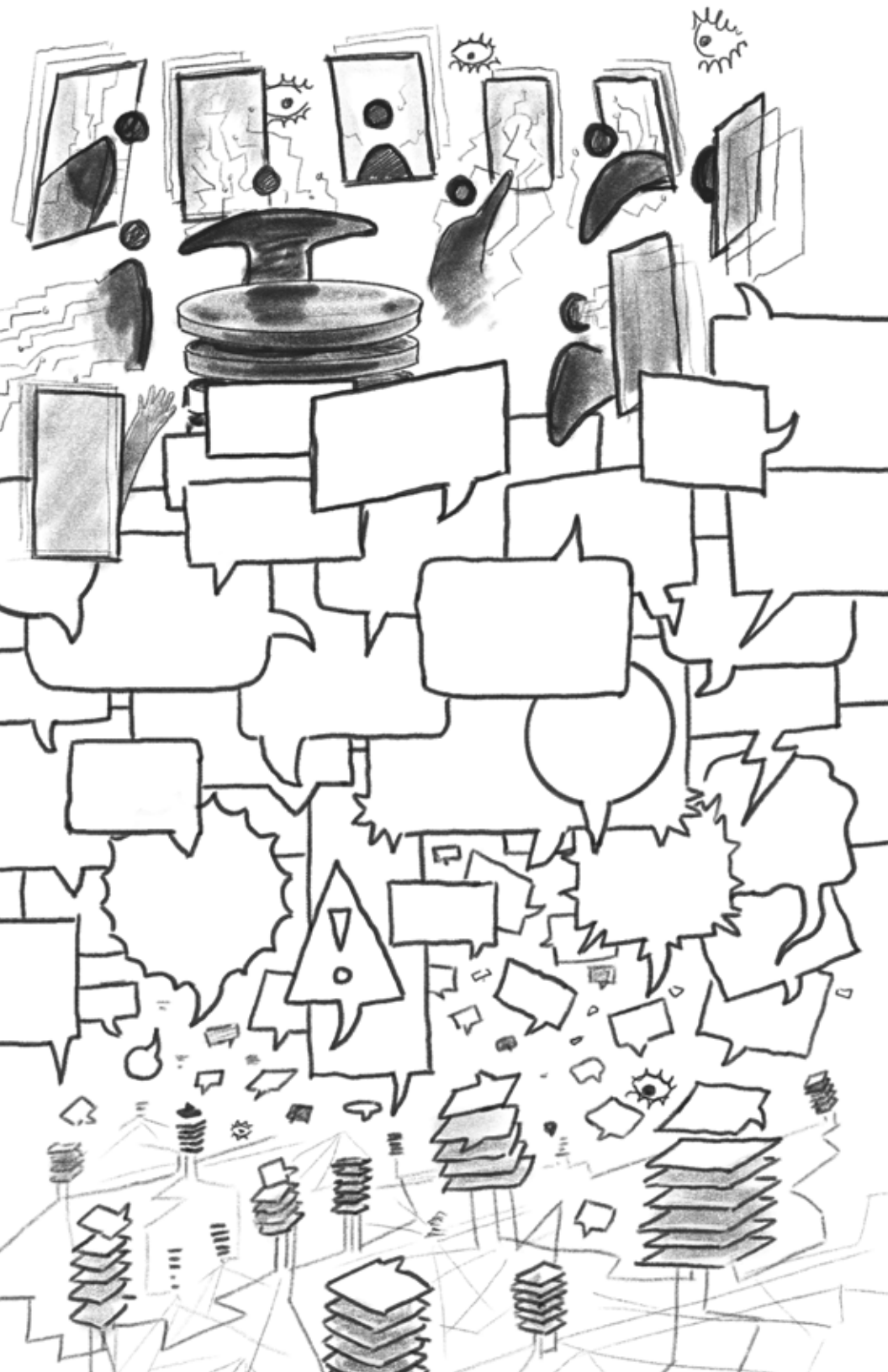

Members of each group reflect on their governance. Changes might have to be made to decide how they might fit into this emerging confederation. A social-media platform deliberates on designs for a shared identity system that could enable polling user-members on important issues. A tech-workers union designs teach-ins to help their members engineer technologies in line with the convention's proposed digital-rights platform. A mutual-aid group begins a local campaign to connect currently-offline community members to new avenues of receiving support. The gears are in motion as something big comes together, something that even starts to feel holy.

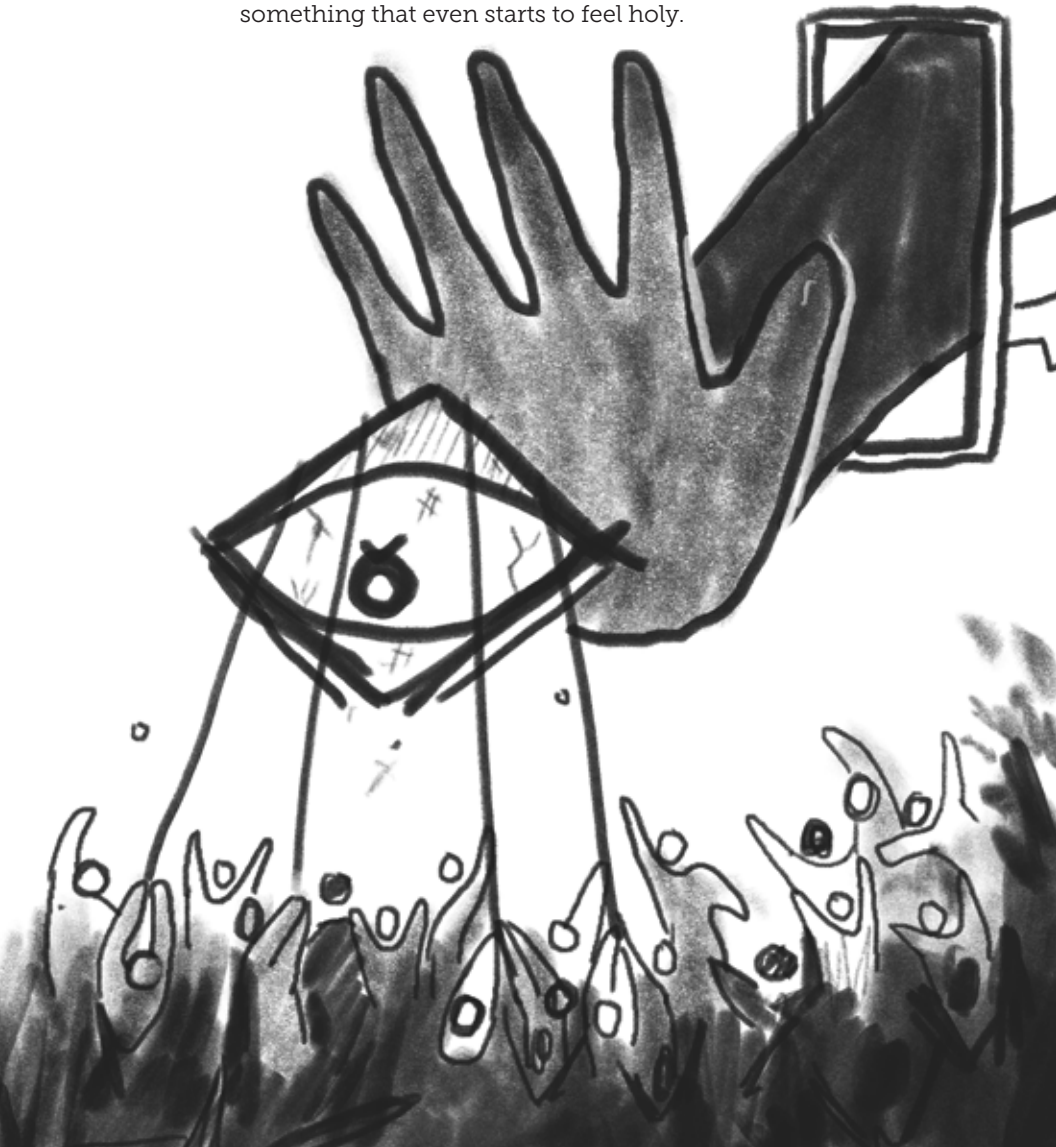

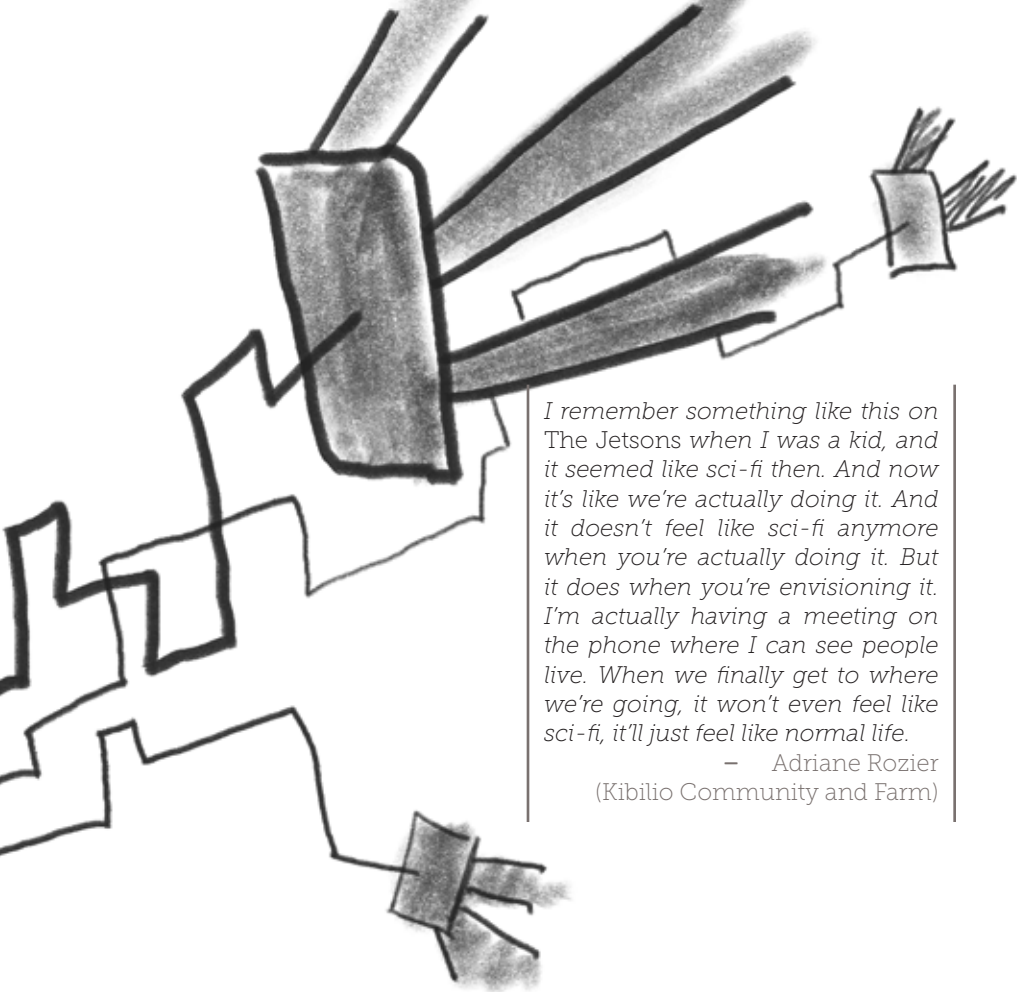

*I remember something like this on The Jetsons when I was a kid, and it seemed like sci-fi then. And now it's like we're actually doing it. And it doesn't feel like sci-fi anymore when you're actually doing it. But it does when you're envisioning it. I'm actually having a meeting on the phone where I can see people live. When we finally get to where we're going, it won't even feel like sci-fi, it'll just feel like normal life.*

— Adriane Rozier  
(Kibilio Community and Farm)

---

**Care work** is the labor that maintains and nourishes the human participants in a stack. It has often been gender-segregated and undervalued, which means that making it visible and just requires intention and commitment.

— *example*

**\$ DisCO.coop, virtual care lab**

---

> I pulled an angel card yesterday, and it said to allow love and support of others in, rather than trying to handle everything yourself. This can take the pressure off and simultaneously nurture you. That's what I randomly pulled, and in the end I realized that we had the tools to do this ourselves.

— Adriane Rozier (Kibilio Community and Farm)

---

~/Tool/Care work



CRAFT  
a  
STACK  
with  
LOVE



Here we are.  
We start  
and end  
where we are.

Weaving a spell for our sacred stacks needn't involve any techno-magic; let's look at what's ready-to-hand. The tools we're already using, could we use them better, more collaboratively? For a moment, let's step into the present-at-hand and see our work and connections more clearly. Take stock of what's there before adding something new; think of affordances and extensibility: maybe what we already have is enough.

*I'm looking for more communication with residents, because our board meetings are so closed in for so long. We're in tough philosophical debates and not many people want to get into that, so I just hope that I can get more resident communication, so that I can learn about everybody's interests. I also hope we can have some more community meals.*

— Juston Martin  
(Sans Souci Cooperative)



*We take a neutral approach in our entangled list of technological platforms. Especially for things like Zoom: they have the funding to make it more accessible. That's real. Things like transcription, the auto-captioning, and being able to dial in. We take that into consideration, in terms of the priorities that we have and how we want to design. But we also have this push to try and explore other things, for particular folks who have disclosed an interest in doing this. Setting up our own handmade websites is one way of just at least alluding to the fact that there's there's more beyond what the tools we have can offer.*

— Alice Yuan Zhang  
(virtual care lab)

The call to craft sacred stacks does not require adding or removing, not even engineering or understanding, necessarily. We started with love, and we can end there. What does love mean in community, mediated with technology?

- to hold the pleasure of the other above the convenience of tools
- to design in ways that helps others understand, rather than veiling systems in mystique
- to give power to communities, not just to technologists or their employers
- to probe possibilities, to try out options, to do the hard work so that the stack comes more easily to others
- to care for and maintain the stack so it lives as long as it needs to
- to hear one's community and evolve the stack to delight each other
- to defend one's people from the incursions of colonizers
- to build the stack so that it treads lightly upon the earth

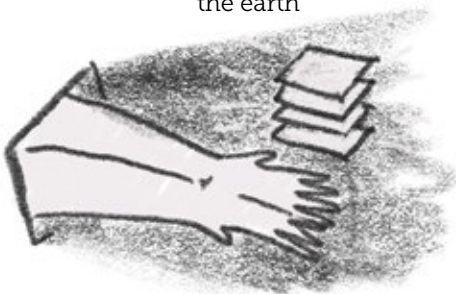

*My father used to go and around and help the neighbors. I just realized, because I was so happy being out there, helping our neighbors, it felt like he was there and that I had a connection to the spirit world, the sacred world.*

— Peggy Kuhn  
(Sans Souci Cooperative)

Love means ordering our loves rightly, discerning what goes where.

“AI” Reply

*Love is about taking the time to understand what matters to the people we love. It is about listening to them and being in tune with their feelings and needs, to the point where we can guess what they want and need even without them having to express it.*

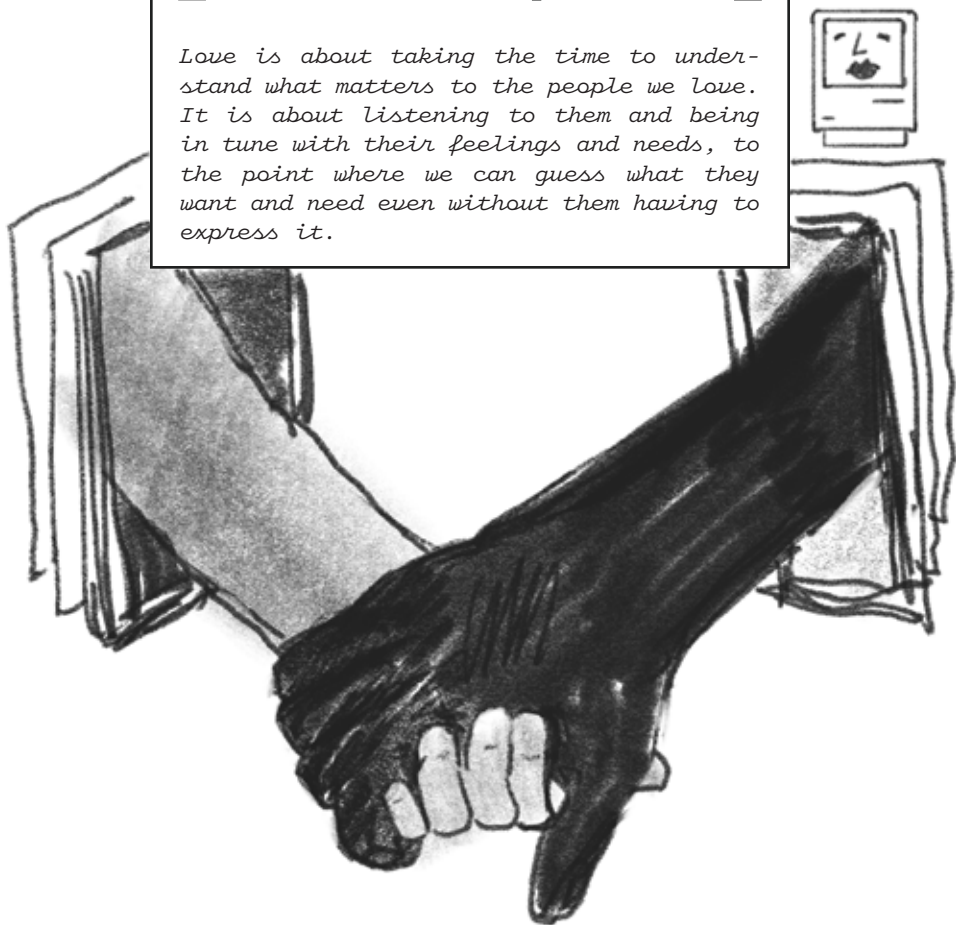

---

**Maintenance** is the work of cleaning, use, and repair that keeps the layers of a stack functioning as needed. It can be a creative, radical act that enables machines and institutions to continue operating longer, and in different ways, than their designers intended.

- example -

\$ The Maintainers, Media Archaeology Lab

---



# 7 INCANTATIONS

WINTER PREPARATIONS NEXT  
FLIP PHONES CLOUD  
TEXT MESSAGES

DATABASE MANAGEMENT SOLIDARITY CIRCLES TOOLS FOR ABOLITION  
ACTION NETWORK NEWSLETTERS

INDIGENOUS TIME RESPECTING  
GATHER STORIES TRANSLATION TOOLS  
WIKIS  
Tree data

LEARNING THROUGH MUSIC LEADERSHIP  
RELO MOBILE APPS

IN-CROP Paperwork  
COMMUNITY AGREEMENTS  
FILM FOOTAGE, WhatsApp,  
NEW MOON CEREMONIES

SIGNAL VOICES for the VOICELESS  
HARDDRIVES  
PRESS CARDS

BE WITH US AND FILL OUR  
STACKS WITH THE  
STUFF of LIFE

---

**Mentorship** can mean people with certain technical skills accompanying those who want to develop those skills. This may become reciprocal, since the mentee will also typically have other kinds of skills the mentor can learn from.

- example -

\$ **Detroit Community Technology Project, DiscoTech**

---

> We hope to have a Elders Council. That will help us. Especially elders of color. Elders, you know, are really about the past and wisdom and experience. But they may not be able to be on a plane to be with us in person. Will they know how to use Zoom? Well, we'll figure it out, you know.

- Adriane Rozier (Kibilio Community and Farm)

---



## Further explorations

Akomolafe, Bayo. *These Wilds Beyond Our Fences: Letters to My Daughter on Humanity's Search for Home*. North Atlantic Books, 2017.

Arendt, Hannah. *Love and St. Augustine*. University of Chicago Press, 1996 [1929].

Argast, Andi. "Staking' Identities: Looking at the Practicalities of Transforming DAOs into Co-ops." *Dripline* (August 11, 2022).

Benjamin, Ruha. *Race After Technology: Abolitionist Tools for the New Jim Code*. Polity, 2019.

Bratton, Benjamin H. *The Stack: On Software and Sovereignty*. MIT Press, 2016.

brown, adrienne maree, and Walidah Imarisha. *Octavia's Brood: Science Fiction Stories from Social Justice Movements*. AK Press, 2015.

Catlow, Ruth, and Penny Rafferty, eds. *Radical Friends: Decentralised Autonomous Organisations & the Arts*. Torque Editions, 2022.

Costanza-Chock, Sasha. *Design Justice: Community-Led Practices to Build the Worlds We Need*. MIT Press, 2020.

Detroit Digital Justice Coalition. *How to DiscoTech*. Allied Media Projects, 2012.

Driscoll, Kevin. *The Modern World: A Prehistory of Social Media*. Yale University Press, 2022.

Echchaibi, Nabil. "What Are We Fighting For? Academia or the Humility of Knowledge." In *Rethinking Media Research for Changing Societies*, edited by Matthew Powers and Adrienne Russell, 195–204. Cambridge University Press, 2020.

Halifax, Joan. *The Fruitful Darkness: A Journey Through Buddhist Practice and Tribal Wisdom*. Grove Press, 2004.

hooks, bell. "Homeplace (A Site of Resistance)." In *Yearning: Race, Gender, and Cultural Politics*, 41–49. South End Press, 1990.

Hoover, Stewart M. *Religion in the Media Age*. Routledge, 2006.

Kelty, Christopher M. *Two Bits: The Cultural Significance of Free Software*. Duke University Press, 2008.

Klassen, Shamika and Xeturah Woodley. "Techno-womanism: Foundations for Social Justice in and through the Technosphere." *Proceedings of Society for Information Technology & Teacher Education International Conference*, 657–664 (2019).

Lofton, Kathryn. *Consuming Religion*. University of Chicago Press, 2017.

Maurin, Peter. *Easy Essays*. Wipf & Stock, 2010.

Rajabi, Samira. *All My Friends Live in My Computer: Trauma, Tactical Media, and Meaning*. Rutgers University Press, 2021.

Sacred Design Lab. *Principles for Online Ritual Design*.

Schneider, Nathan. "Governable Stacks against Digital Colonialism." *TripleC: Communication, Capitalism & Critique* 20, no. 1 (January 12, 2022).

sutton, mai ishikawa. "The Debate Over DWeb vs. Web3 & The Decentralized Elephant in the Room." *Dripline* (May 17, 2022).

Troncoso, Stacco, and Ann Marie Utratel. *If I Only Had a Heart: A DisCO Manifesto*. Disco.coop, 2019.

Williams, Saul and Anisia Uzeyman, directors. *Neptune Frost*. Kino Lorber, 2021.

Winner, Langdon. *The Whale and the Reactor: A Search for Limits in an Age of High Technology*. University of Chicago Press, 1998.

---

**Acknowledgment** is the practice of recognition, wherever it is appropriate or necessary, the colonization of land, cultural appropriation, environmental impact, or other injustices that might otherwise be ignored by the dominant society. Corporate stacks typically try to keep their impacts hidden from users, so deliberate research may be needed to identify what should be acknowledged.

- example -

**\$ Atlas of Surveillance, Native Land Digital**





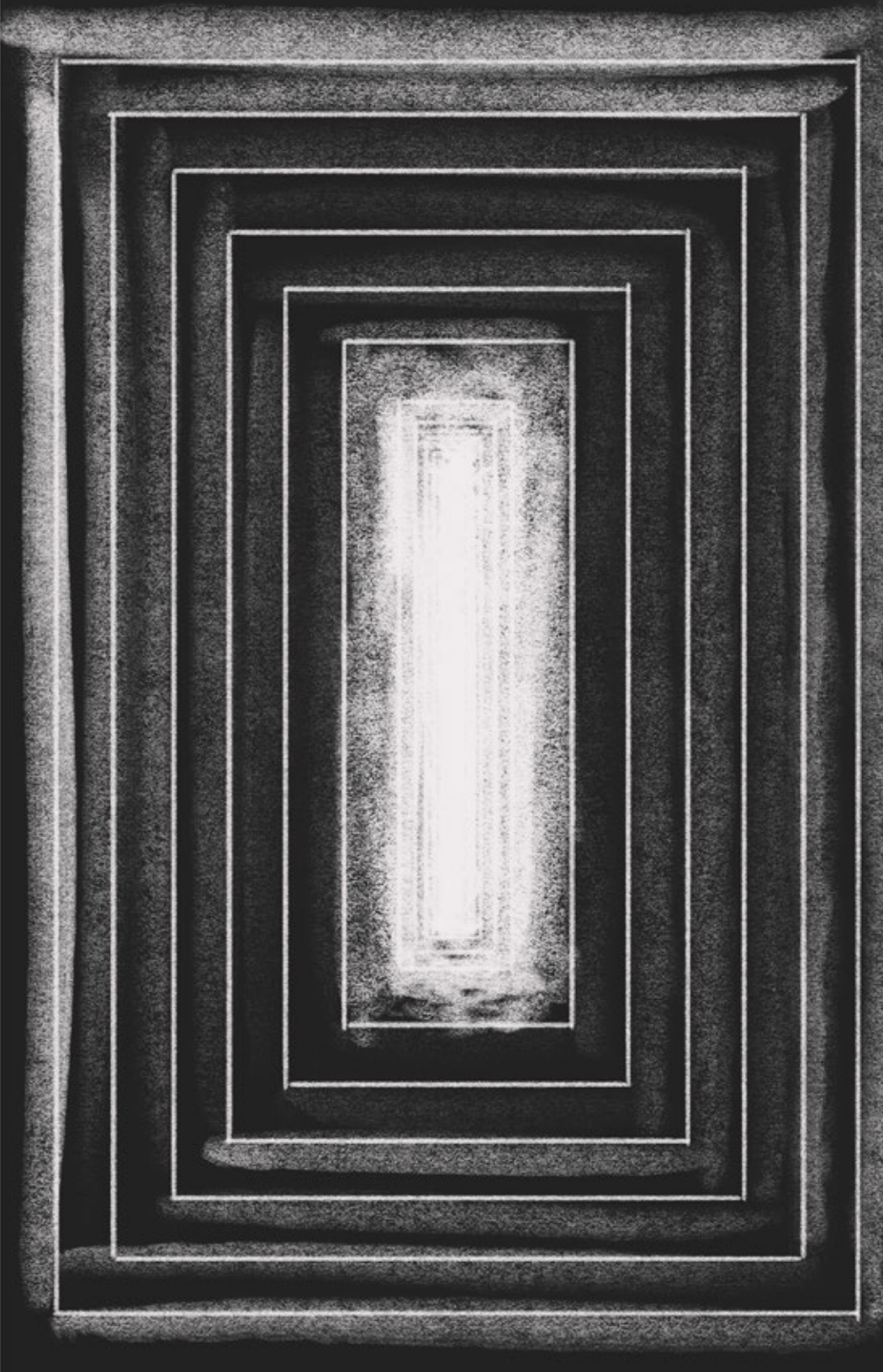

University of  
Colorado  
Boulder

Media  
Economics  
Design Lab

Center for  
Media, Religion,  
and Culture

ART  
THE  
LAYOUT

a  
METALABEL  
shop

Composed and compiled by

<http://il.medlab.metalabel.xyz>

Andi Argast  
James Brennan  
Nabil Echcharbi  
Drew Hornbein  
Shamika Klassen  
Samira Rajabi  
Nathan Schneider

RITUAL  
POINT  
RITUAL POINT STUDIO

with  
SUPPORT  
from

EILECOIN  
FOUNDATION  
for the  
DECENTRALIZED  
WEB

STARLING  
SLAB for  
DATA  
INTEGRITY

HENRY  
LUCIE  
Foundation

PARTNER COMMUNITIES  
Kibillo Community & Farm  
Meli BBS Network  
sons Soyol Cooperative  
Survivors Know

Unheard Voices Outreach  
Yerba Buena Center for the Arts  
Iraqi Journalists Rights Association